

# ME65 User Manual



## Table of Contents

About the Guide .....	4
Getting Started .....	5
Unpacking .....	5
Device Features .....	6
Setting Up the Device .....	8
Installation Guide .....	8
Caution on Battery Charging .....	9
Charging Method .....	9
Using the Device .....	12
Home Screen .....	12
Setting Home Screen Rotation .....	12
Status Bar .....	13
Notification Icons .....	14
Status Icons .....	14
Managing Notifications .....	15
Opening the Quick Access Panel .....	16
Quick Access Panel Icons .....	16
Battery Management .....	17
Checking Battery Status .....	17
Monitoring Battery Usage .....	18
Low Battery Notification .....	19
Waking the Device .....	19
USB Communication .....	20
Enable USB Debugging .....	20
Transferring Files .....	22
Transferring Photos .....	23
Charging Mode .....	24
Disconnecting from the PC .....	24
Power Off .....	25
Restart .....	26
Task Manager .....	27
About Device .....	27
Upgrading .....	28
Settings .....	29
Accessing Settings .....	29
Display Settings .....	30
General Sound Setting .....	33
System Settings .....	34
Notifications .....	37

Setting App Notifications.....	37
Controlling Lock Screen Notifications.....	39
Applications.....	40
Installed Applications.....	40
Accessing Apps.....	41
Switching Between Recent Apps.....	42
Key Mapping.....	42
MeTOF Operation Method.....	46
MeMobilityDesk WorkStation.....	55
Data Capture.....	56
Scan engine.....	56
Scan Settings.....	56
Reader Params.....	62
Data Format.....	63
Symbology settings.....	65
Reset.....	66
Import config/Export config.....	66
Wireless.....	67
Connect to WLAN.....	67
WWAN.....	70
Bluetooth.....	72
Change Bluetooth Device Name.....	73
Bluetooth Connection.....	74
Management Paired Devices.....	74
Connection Preferences.....	75
Accessories.....	77
List of Standard Accessories.....	77
List of Optional Accessories.....	78
Maintenance and Troubleshooting.....	81
Maintenance.....	81
ME65 Cleaning.....	81
Troubleshooting.....	82

# About the Guide

## Introduction

This Guide offers information on usage of ME65 mobile computer and its accessories.

Note: The screens and windows described in this Guide are samples, which can differ from actual ones.

## Determining the Serial Number

Before contacting Customer Support, determine the serial number of your device.

Touch **Settings > About phone > Phone SN**.

## Determining Software Versions

Before contacting Customer Support, determine the current software version on your device.

1. Touch **Settings > About phone**.
2. Scroll to view the following information:

- Device name
- Phone number (sim slot 1)
- Phone number (sim slot 2)
- Legal information
- SIM status (sim slot 1)
- SIM status (sim slot 2)
- Model
- Phone SN
- IMEI (sim slot 1)
- IMEI (sim slot 2)
- Android version
- Wi-Fi MAC address
- Bluetooth address
- Build number

## Service information

If you have a problem with your equipment, contact Customer Support for your region. Contact information is available at: [www.meferi.com](http://www.meferi.com).

When contacting support, please have the following information available:

- Device SN (Phone SN) (found on manufacturing label)
- Model number or product name (found on manufacturing label)
- Software type and version number

Customer Support responds to calls by email or telephone within the time limits set forth in support agreements.

# Getting Started

## Introduction

This chapter describes product information and instruction of device for the first time.

## Unpacking

To unpack the device:

1. Carefully remove all protective material from the device and save the shipping container for later storage and shipping.
2. Verify that the following items were received:
  - ME65 Device×1
  - Battery×1
  - Power Adapter×1
  - USB cable×1
  - Hand Strap×1
  - Quick start guide×1
3. Inspect the equipment for damage. If any equipment is missing or damaged, contact customer support center immediately.
4. Please remove the screen shipping protective film before using.

## Device Features

### Front View

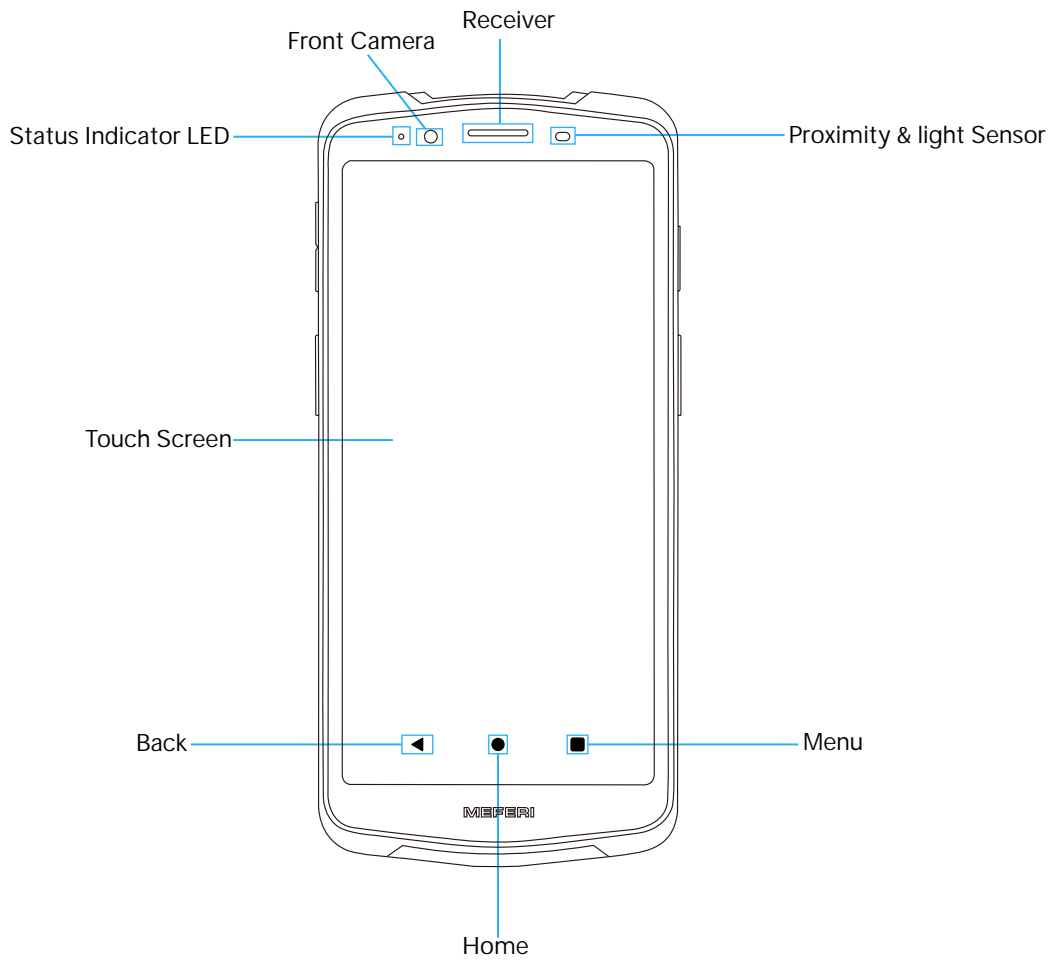

### Side View

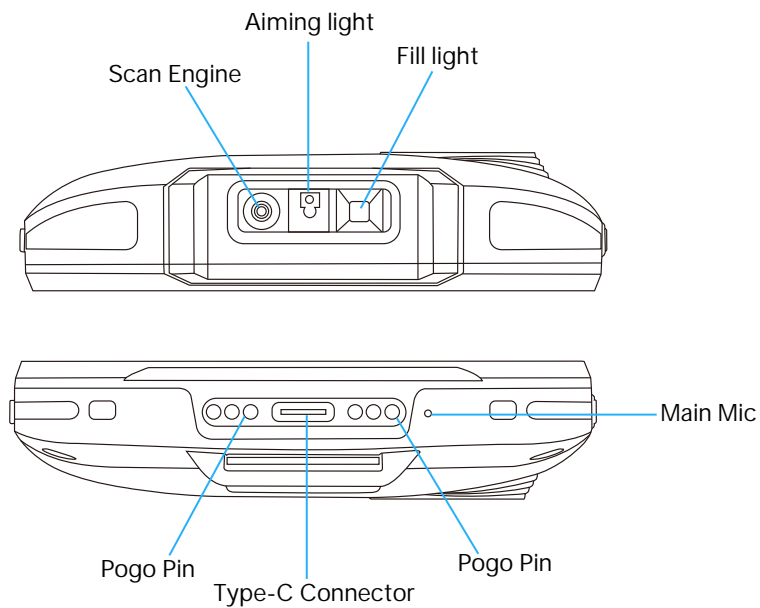

### Rear View

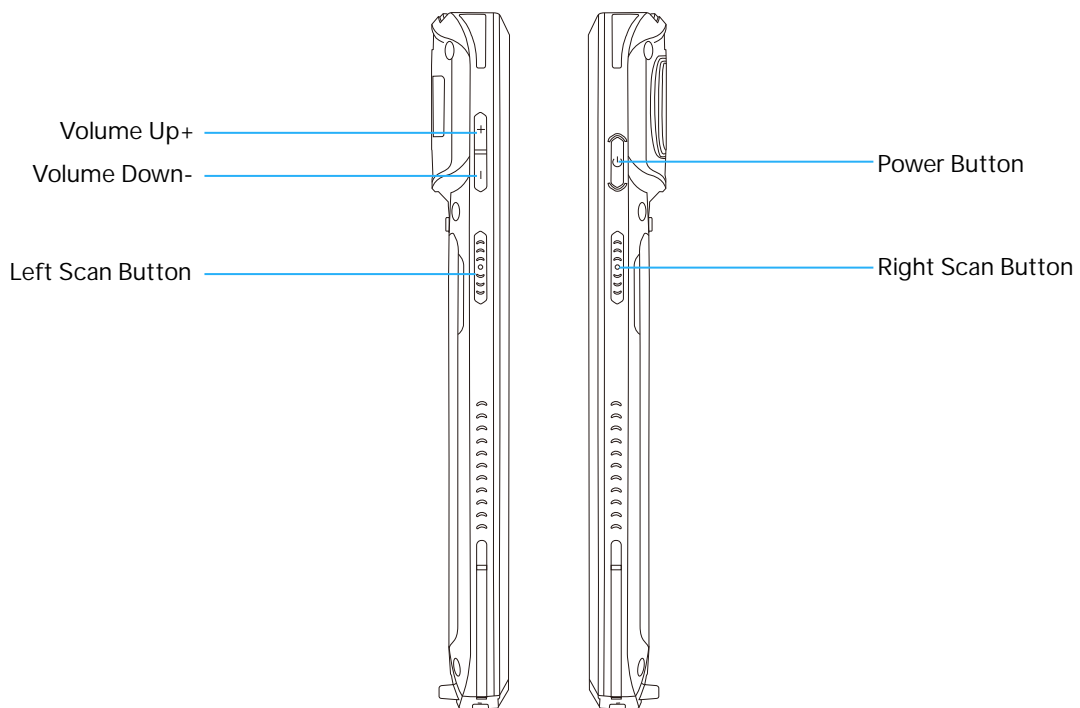
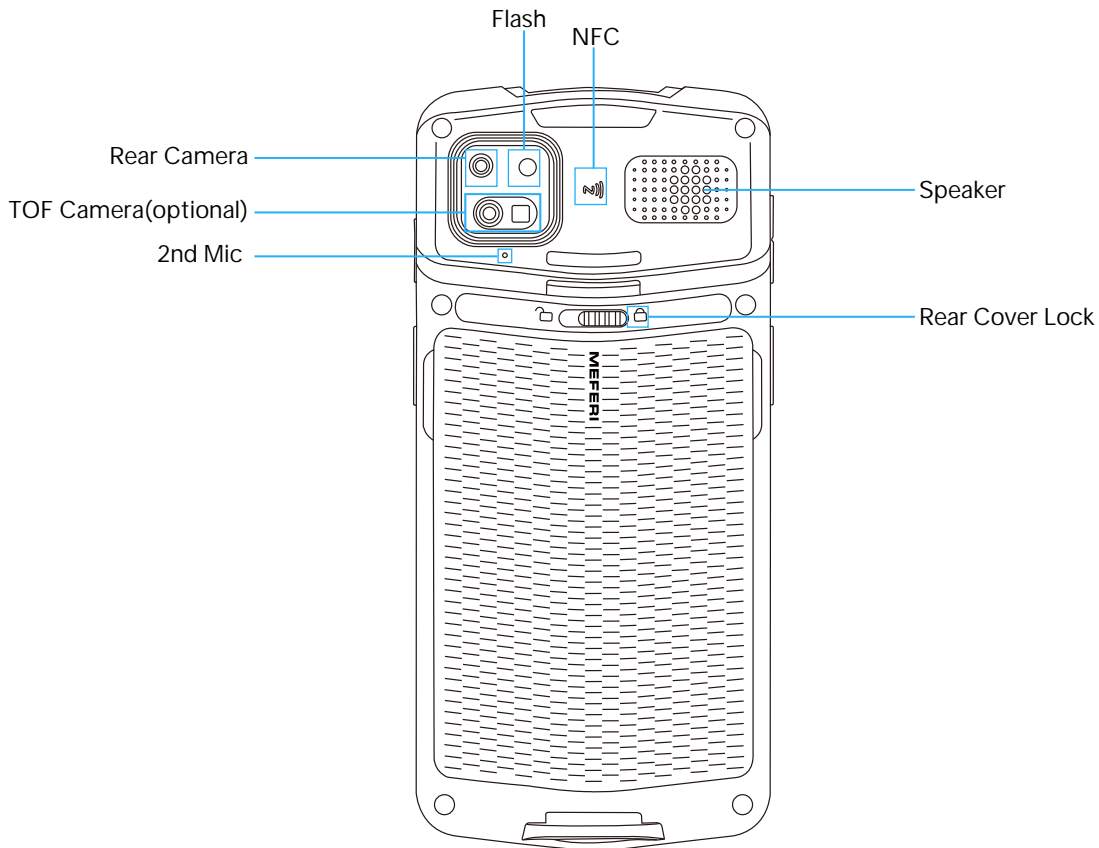

## Setting Up the Device

To start using the device for the first time:

1. Install a micro secure digital (SD) card (optional).
2. Installing a nano SIM card (optional).
3. Install hand strap (optional).
4. Install the battery.
5. Charge the device.
6. Power on the device.

## Installation Guide

### Instruction on SIM/TF Card installation

Use the silver tab on the upper left corner to pull out the SIM card holder. Put the SIM card into the corresponding slot (as shown in the picture). Push the holder fully into:

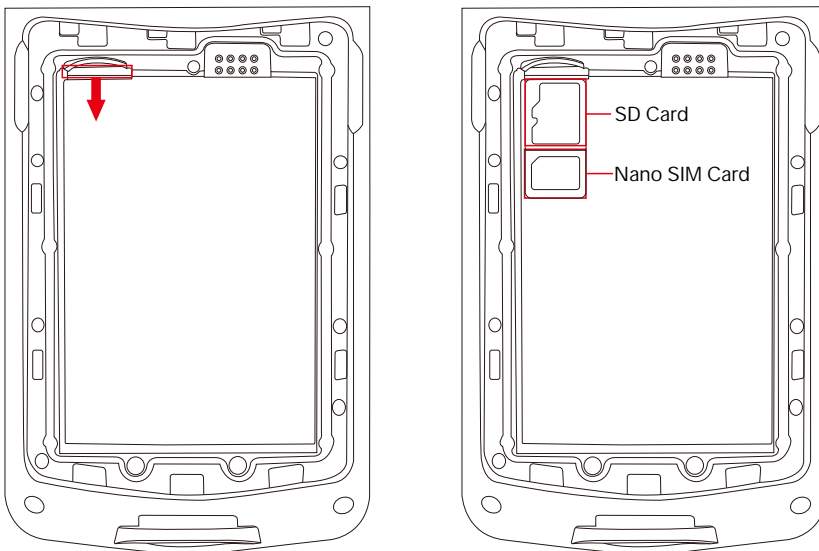

#### Note:

- a) SIM card are Nano SIM cards.
- b) Overexertion should be avoided when installing or removing the battery.

### Instruction of battery

While installing the battery, please note the direction of installing the battery.

Load the rear end of the battery in the device's battery slot and press the battery firmly.

Please do not push the battery into the device with force, turn the battery cover fastener right to the lock position.



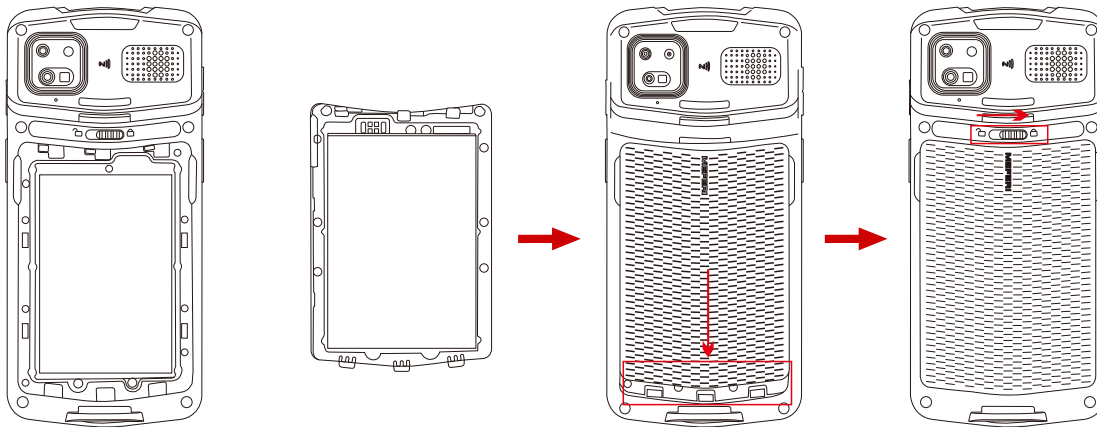

## Caution on Battery Charging

1. Please do not use or charge the device in any environment with too high or low temperature;
2. Please use the charger or cradle that comes with the product to charge the battery;
3. If the device (including the battery) is not used for the moment, please separately store the battery and device and pack them in PE bags or other insulated bags in the original package in case that they become damp or contact with other electronic devices. Do not store the unpacked battery in a stack;
4. Please do not idle the device for over 3 months; be sure to charge and discharge the battery not used for the moment once per 3 months, where the stored battery should be 60%~70% charged ;
5. The lithium battery should be stored somewhere cool, dry and ventilated. It is advised to be stored in a 0~28℃ environment.

## Charging Method

### Charging with Type-C USB cable

For Type-C USB cable, link one end to computer and the other to device. In charging, the device's charge indicator is red, which will turn green when the device is fully charged.

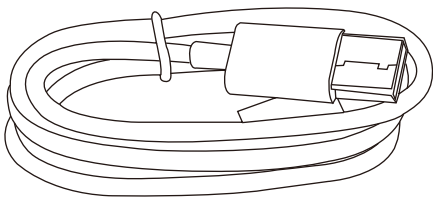

Type-C USB Cable

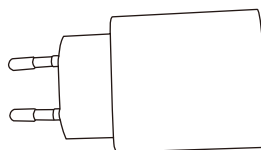

Power Adapter

### Charging with Single Slot Cradle

Cradle can charge the device (including the battery) and a battery at the same time.

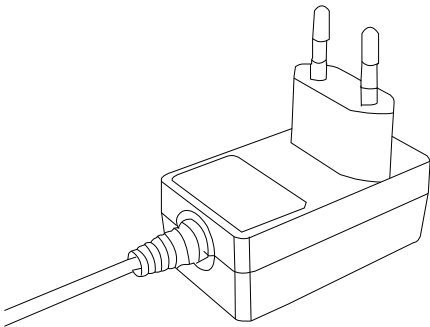

DC Power Supply

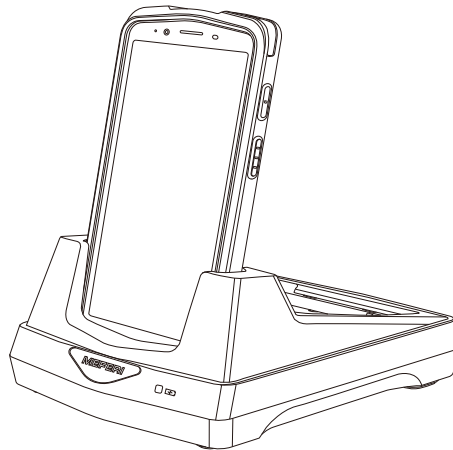

Charging

1. Connect the DC interface of the base to the power adapter.
2. Load the rear end of the battery in the device's battery slot and press the battery firmly. When the battery is correctly installed, the charge indicator will turn red. When the battery is fully charged, the indicator will turn green.
3. Put the back of the device in the slot cradle of the base and fasten left and right fasteners to complete installation of the device. And in this case, the device's charge indicator will turn red.

#### 4-Slot Battery Charger Only with Battery Charger

1. Provides 12V/4A power for operating the device.
2. 4-slot battery charger charges four batteries.

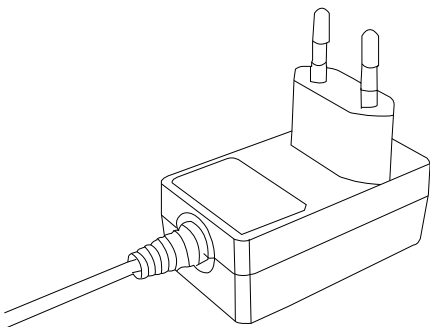

Power Supply-12V/4A/DC

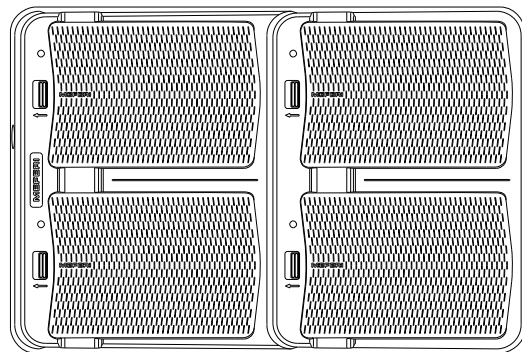

4-Slot Battery Charging

#### Charging with 5-Slot Cradle

1. Provides 24V/5A power for operating the device.
2. 5-slot cradle charges five device and five battery .

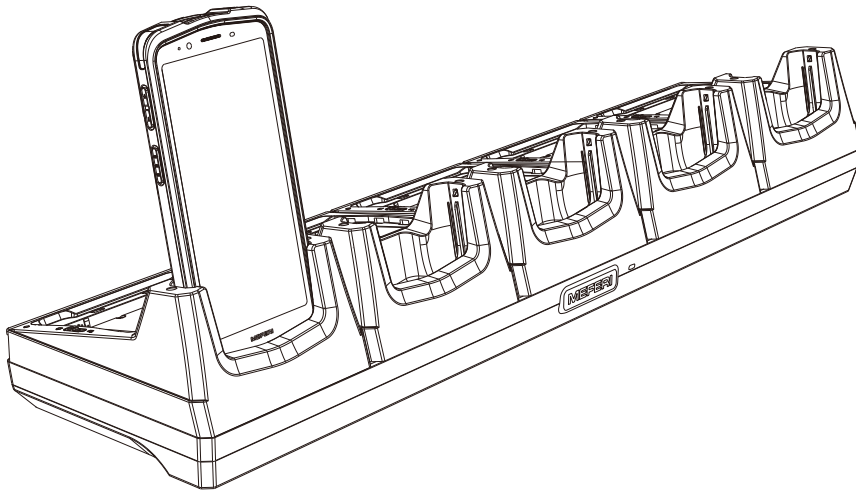

5-Slot cradle Charging

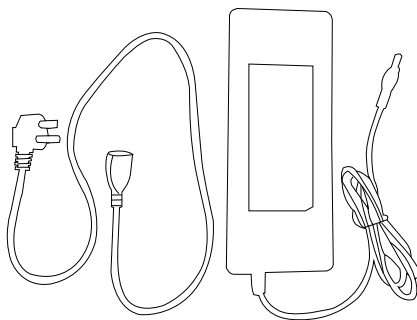

Power Supply-24V/5A/DC

# Using the Device

This chapter explains how to use the device.

## Home Screen

Turn on the device to display the Home screen. Depending on how your system administrator configured your device, your Home screen may appear differently than the graphics in this chapter.

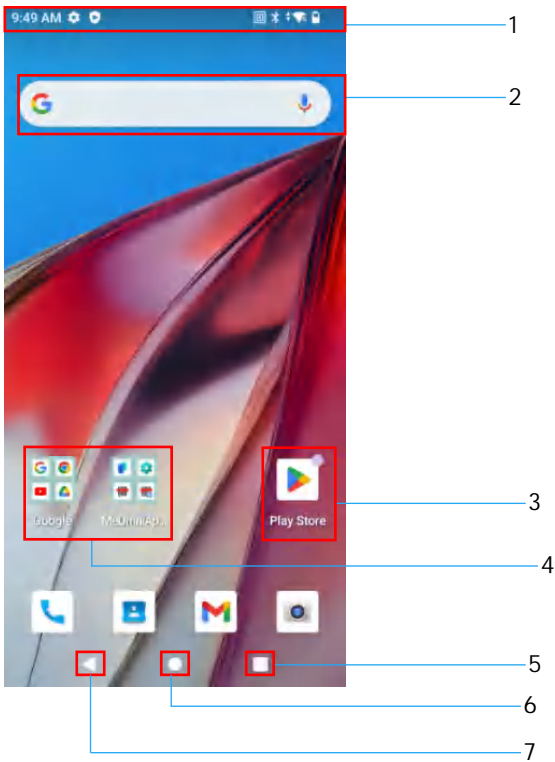

1	Status bar	Displays the time, status icons (right side), and notification icons (left side).
2	Widgets	Launches stand - alone apps that run on the Home screen.
3	Shortcut icons	Opens apps installed on the device.
4	Folder	Contains apps.
5	Menu	Recent apps.
6	Home	Main menu.
7	Back	Back to previous level.

## Setting Home Screen Rotation

By default, the Home screen rotation is disabled.

1. Touch and hold anywhere on the Home screen until the options appear.
2. Touch "Home settings".
3. Touch the "Allow home screen rotation" switch.
4. Touch Home.
5. Rotate the device.

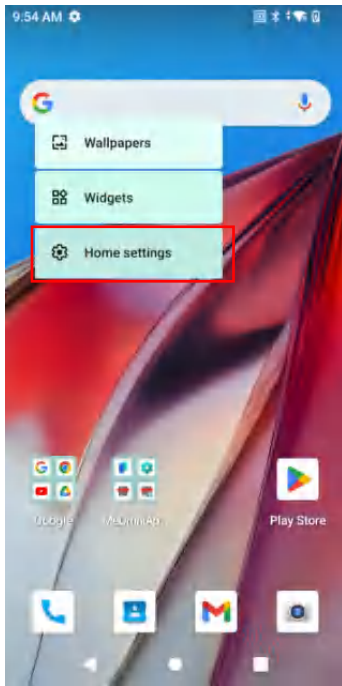

2

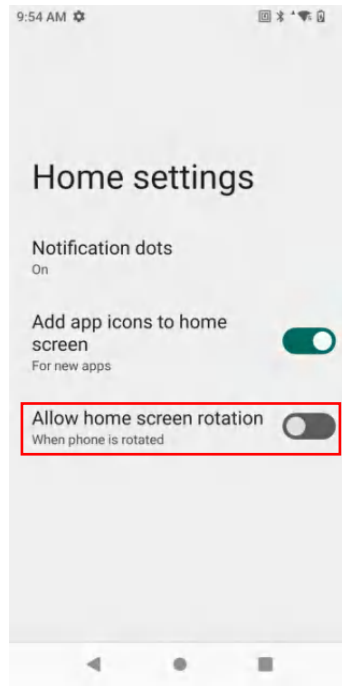
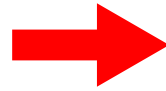

3

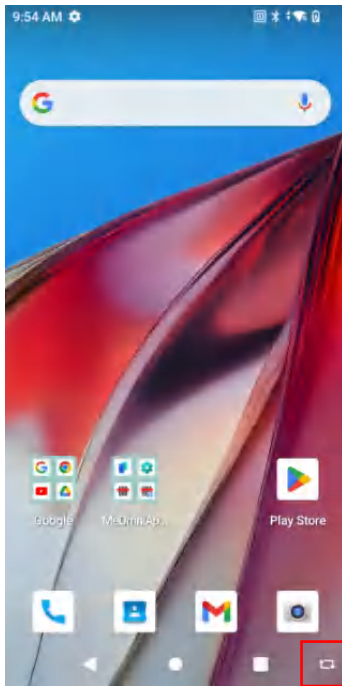

4

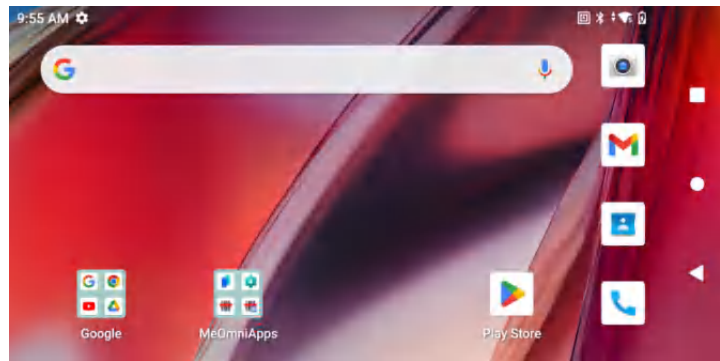
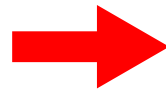

5

## Status Bar

The Status bar displays the time, notification icons (left side), and status icons (right side).











If there are more notifications than can fit in the Status bar, a dot displays indicating that more notifications exist.

Swipe down from the Status bar to open the Notification panel and view all notifications and status.













## Notification Icons

Notification icons indicate app events and messages.

Icon	Description
	Main battery is low.
	More notifications are available for viewing.
	Data is syncing.
	Indicates an upcoming event. AOSP devices only.
	Open Wi-Fi network is available.
	Audio is playing.
	Problem with sign-in or sync has occurred.
	Device is uploading data.
	Animated: the device is downloading data. Static: the download is complete.
	Preparing internal storage by checking it for errors.
	Indicates the ring scanner is connected to the device in HID mode.

## Status Icons

Status icons display system information for the device.

Icon	Description
	Alarm is active.
	Main battery is fully charged.
	Main battery is partially drained.
	Main battery charge is low.
	Main battery is charging.
	All sounds, except media and alarms, are muted. Vibrate mode is active.
	Do Not Disturb mode active.
	Airplane Mode is active. All radios are turned off.
	Bluetooth is on.
	Connected to a Wi-Fi network. Indicates the Wi-Fi version number.
None	Not connected to a Wi-Fi network or no Wi-Fi signal.
	Call is in progress.

## Managing Notifications

Notification icons report the arrival of new messages, calendar events, alarms, and ongoing events. When a notification occurs, an icon appears in the Status bar with a brief description.

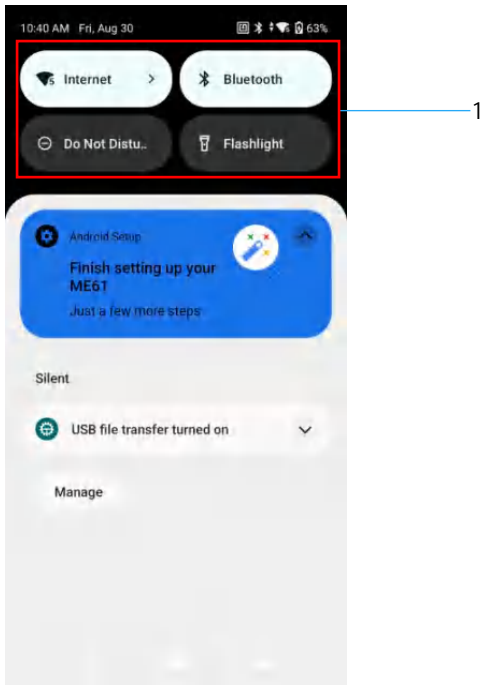

1	Quick settings bar
---	--------------------

- To view a list of all notifications, open the notification panel by dragging the Status bar down from the top of the screen.
- To respond to a notification, open the notification panel and then touch a "notification". The Notification panel closes and the corresponding app opens.
- To manage recent or frequently used notifications, open the notification panel and then touch "Manage". Touch the "APP settings" to turn off all notifications, or touch an "app" for more notification options.
- To clear all notifications, open the notification panel and then touch "CLEAR ALL". All event-based notifications are removed. Ongoing notifications remain in the list.
- To close the Notification panel, swipe the Notification panel up.

## Opening the Quick Access Panel

Use the Quick Access panel to access frequently used settings (for example, "Bluetooth" mode).

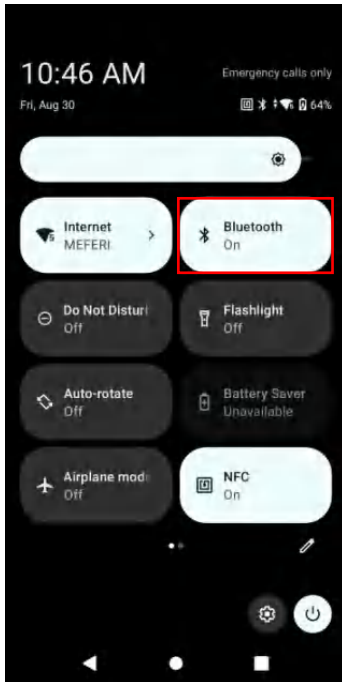

- If the device is locked, swipe down once.
- If the device is unlocked, swipe down once with two fingers, or twice with one finger.
- If the Notification panel is open, swipe down from the Quick Settings bar.

## Quick Access Panel Icons

Quick Access panel icons indicate frequently used settings (for example, "Bluetooth" mode).

Icon	Description
	Display brightness - Use the slider to decrease or increase the brightness of the screen.
	Internet - Turn Wi-Fi on or off. To open Wi-Fi settings, touch the Wi-Fi network name.
	Bluetooth settings - Turn Bluetooth on or off. To open Bluetooth settings, touch Bluetooth.
	Do not disturb - Control how and when to receive notifications.
	Airplane mode - Turn Airplane mode on or off. When Airplane mode is on the device does not connect to Wi-Fi or Bluetooth.
	Auto-rotate - Lock the device's orientation in portrait or landscape mode or set to automatically rotate.
	Flashlight - Turn flashlight on or off.
	Battery saver - Turn Battery saver mode on or off. When Battery saver mode is on the performance of the device is reduced to preserve battery power.



## Editing Icons on the Quick Settings Bar

The first several setting tiles from the Quick Access panel become the Quick Settings bar.

Open the Quick Access panel and touch  to edit, add, or remove settings tiles.

## Battery Management

Observe the recommended battery optimization tips for the device.

- Set the screen to turn off after a short period of inactivity.
- Reduce screen brightness.
- Turn off all wireless radios when not in use.
- Turn off automatic syncing for Email, Calendar, Contacts, and other apps.
- Minimize use of apps that keep the device from suspending, for example, music and video apps.

**NOTE:** Before checking the battery charge level, remove the device from any AC power source (cradle or cable).

## Checking Battery Status

1. Open "Settings" and touch "Battery" . Or, swipe down from the screen open "Quick Access Panel" and touch "Settings icon" choose "Battery".

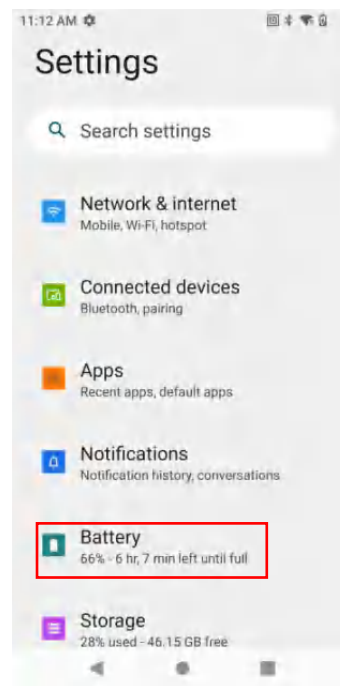
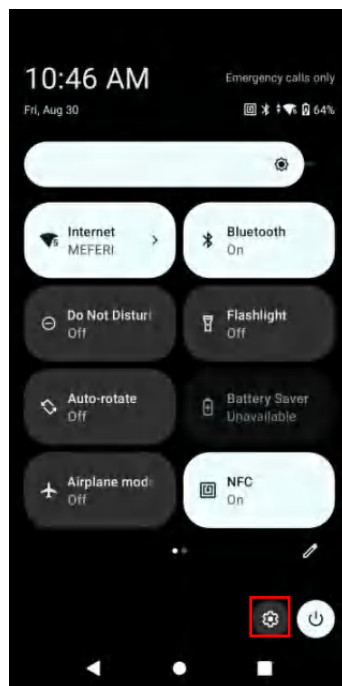
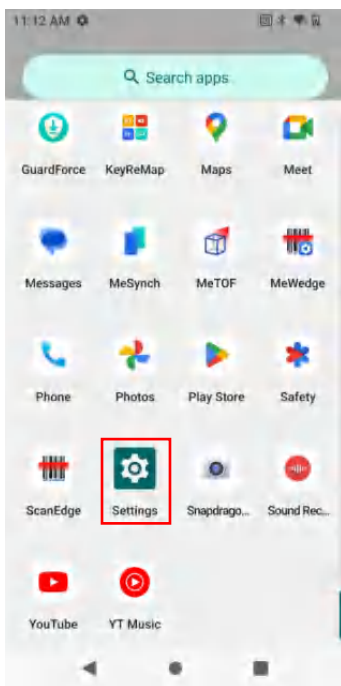

- Battery usage view usage since last full charge.
- Battery level lists the battery charge (as a percentage of fully charged).
- Battery percentage is displayed next to the battery icon.

## Monitoring Battery Usage

The Battery screen provides battery charge details and battery management options to extend battery life. Different apps display different information. Some apps include buttons that open screens with settings to adjust power use. Use the "Disable" or "Force stop" buttons to turn off apps that consume too much power.

- Go to Settings.
- Touch "Battery".

To display battery information and power management options for a specific app:

- Go to Settings.
- Touch "Apps".
- Choose an app - touch "APP battery usage".

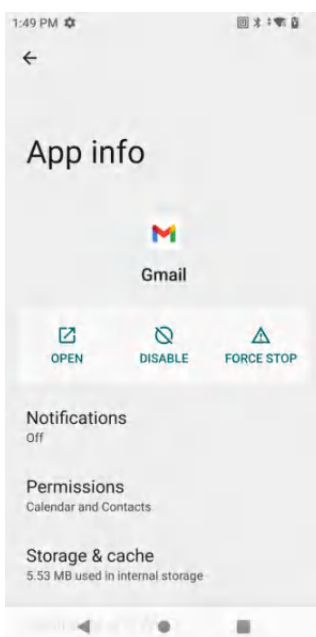
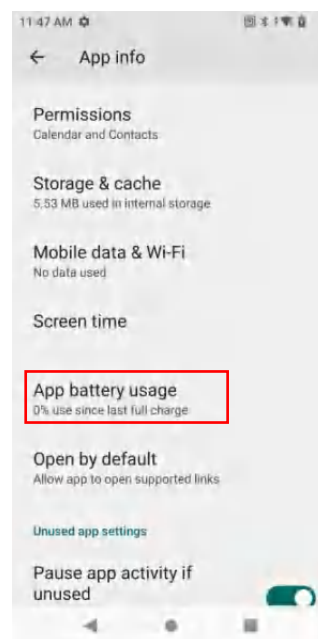
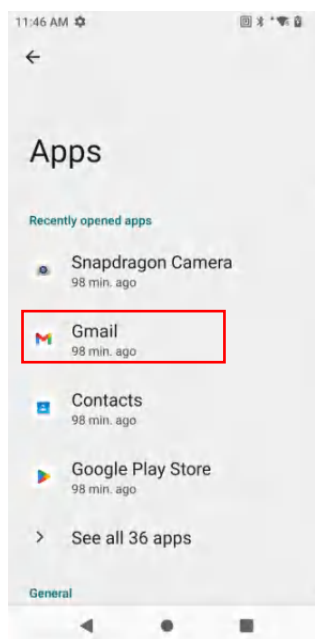
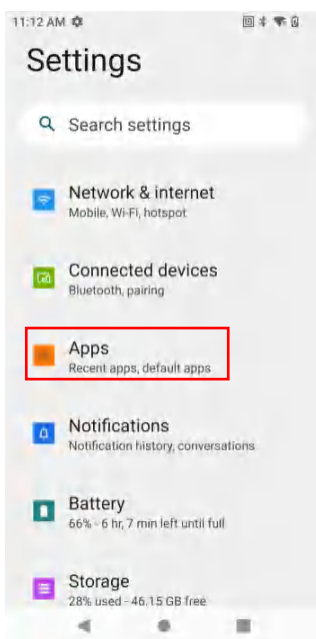

## Low Battery Notification

When the battery charge level drops below the 15% below, the device displays a notice to connect the device to power. The user should charge the battery using one of the charging accessories.

## Waking the Device

The device goes into Suspend mode when you after a period of inactivity (if the never setting is changed to something else in “Settings” > “Display” > “Screen timeout”).

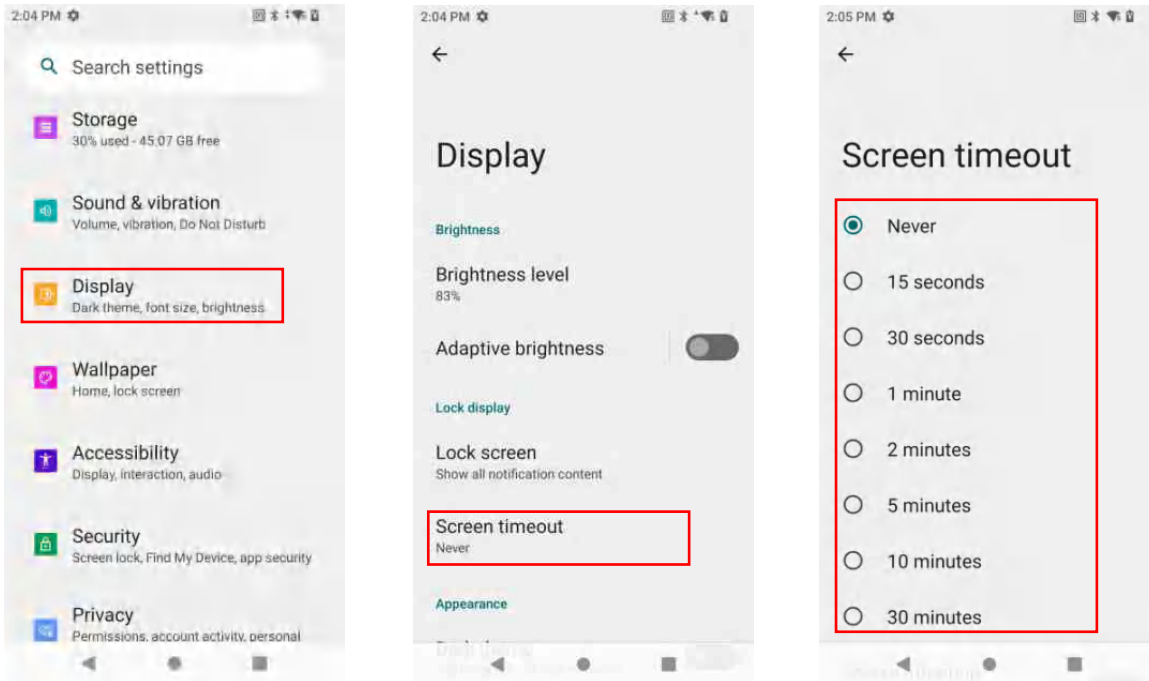

1. To wake the device from Suspend mode, press power button .The Lock screen displays.
2. Swipe the screen up to unlock.

- If the Pattern screen unlock feature is enabled, the Pattern screen appears instead of the Lock screen.
- If the PIN or Password screen unlock feature is enabled, enter the PIN or password after unlocking the screen.

**CAUTION:** If you enter the PIN, password, or pattern incorrectly five times, you must wait 30 seconds before trying again.

- If you forget the PIN, password, or pattern, contact your system administrator.

## USB Communication

insert one end of the device's USB cable to the device and the other to the PC's USB port to connect the device to the PC, press and hold the top of screen at any interface of the device and pull down to enter the USB settings interface:

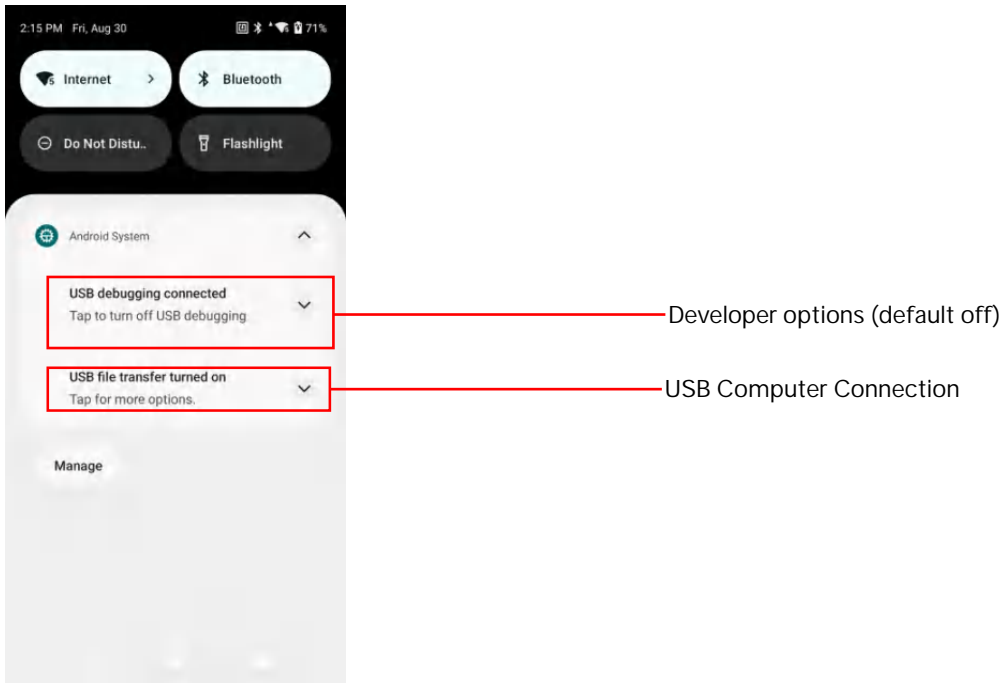

## Enable USB Debugging

1. Open Settings - "About phone" - Click "Build number" 5 times in a row.

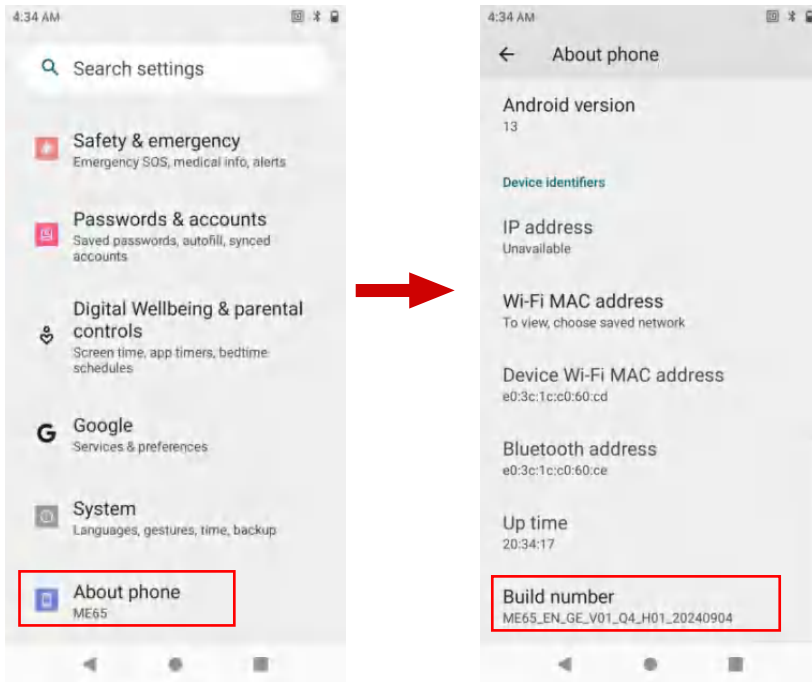

2. Open Settings - "System" - "Developer options".

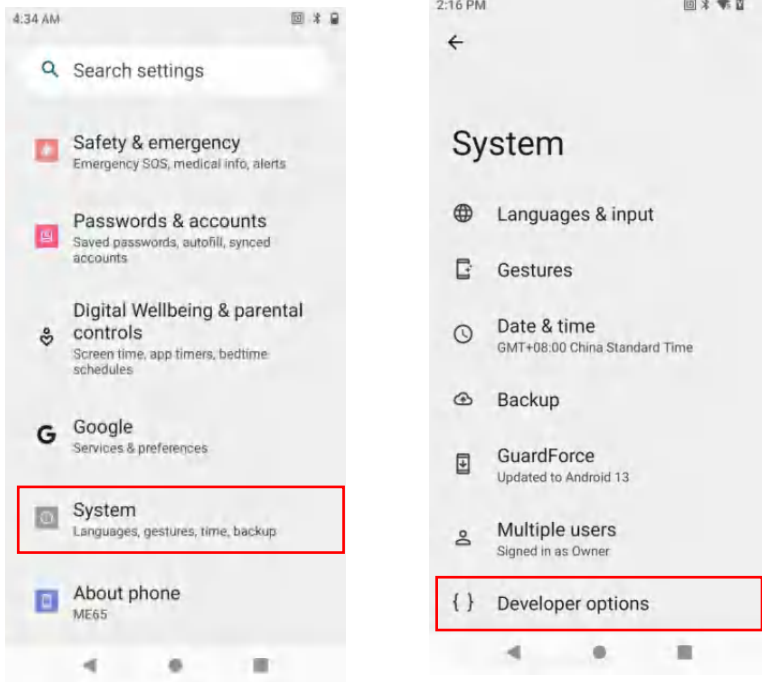

3. Enable USB Debugging to enter the debugging mode.

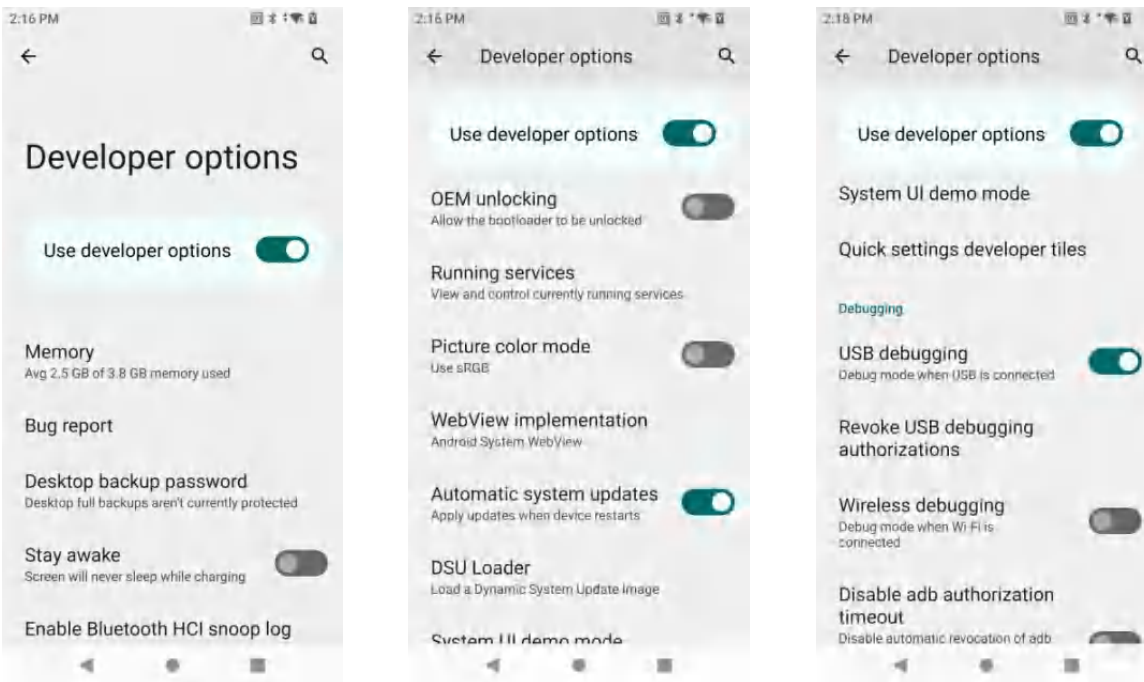

## Transferring Files

1. Connect the device to PC by a USB cable.
2. Pull down the status bar to open the notification panel. Select "File Transfer" in USB preferences to transfer media files to Windows or transfer files by any Android file transfer app to Mac.

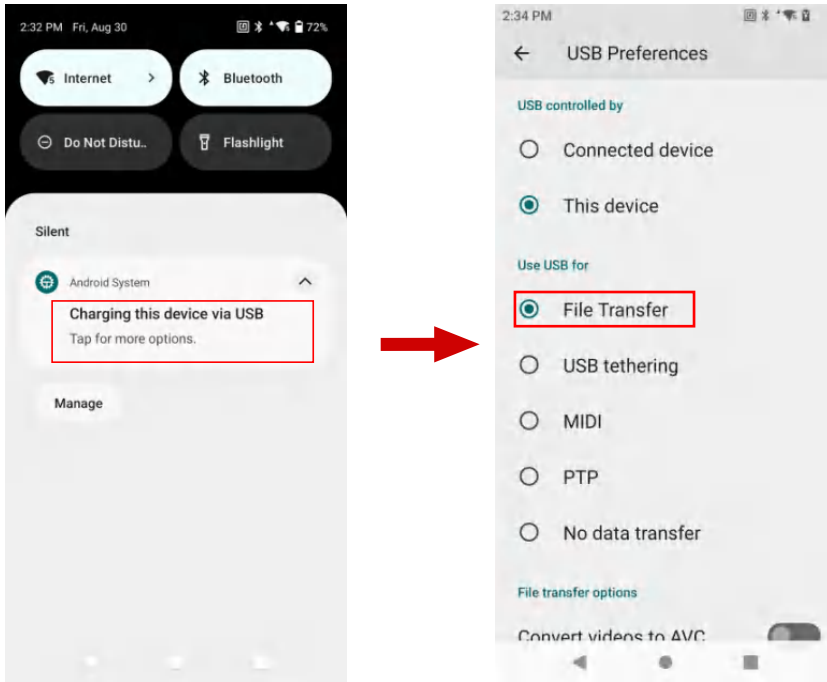

3. At PC end, open My Computer to access ME65 device.



5. Copy files to and from the device or delete files as required.

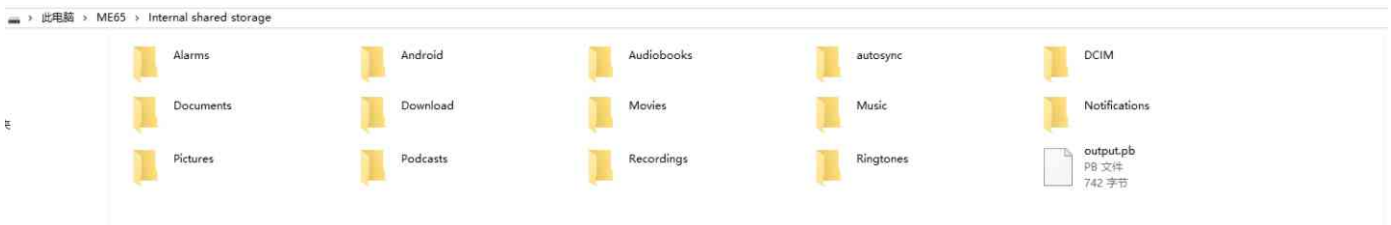

## Transferring Photos (PTP)

NOTE: It is recommended to install a microSD card in the device for storing photos due to limited internal storage.

1. Connect the device to PC by a USB cable.
2. Pull down the status bar to open the notification panel and select "PTP" in USB use for to transfer photos to Windows.

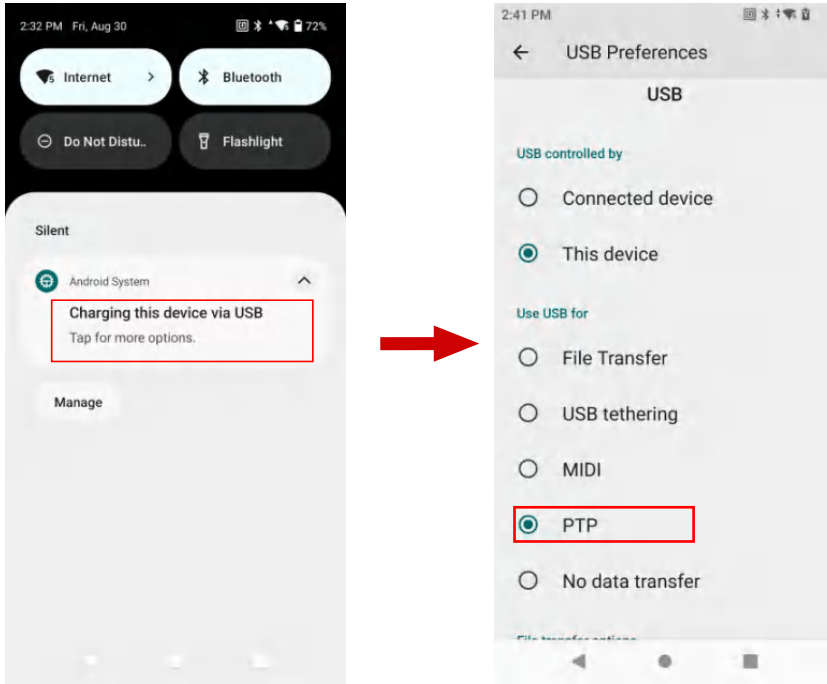

3. At PC end, open My Computer to access ME65 device.



4. Open the SD card or the Internal storage folder.
5. Copy or delete photos as required.

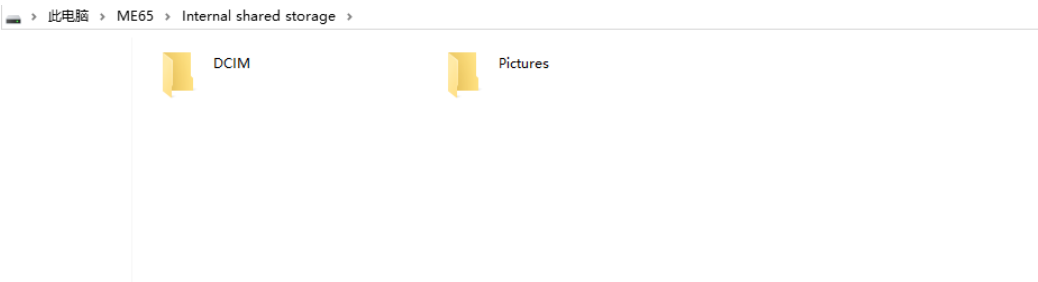

## SD Card mounting

In this mode, no microSD Card directory folder will be shown at PC end until a microSD Card is inserted into PC.

## Charging mode

1. Connect the device to PC by a USB cable.
2. Pull down the status bar to open the notification panel and select "No Data Transfer" in USB Purpose.

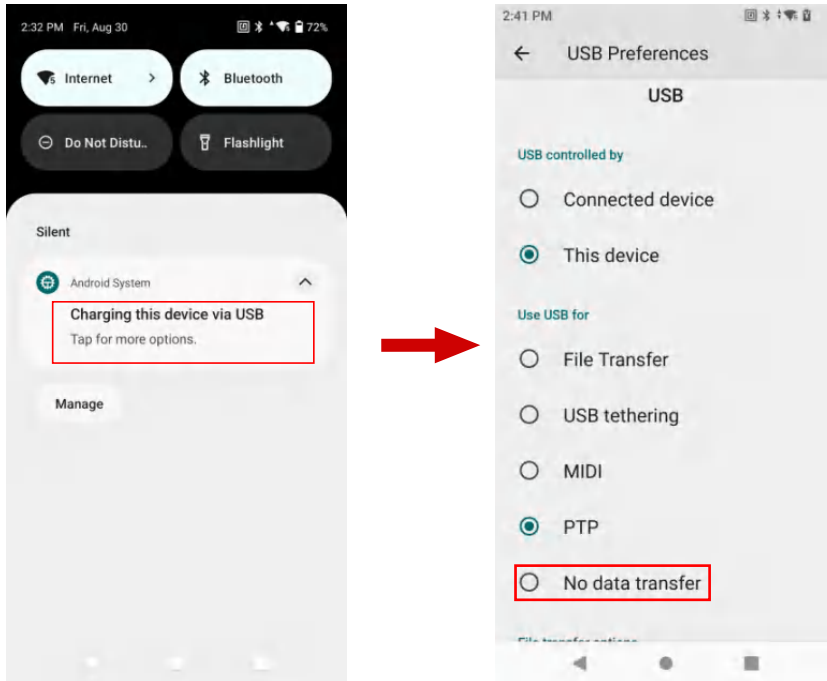

3. In the charging mode, data communication is not available.

## Disconnection from PC

Caution: Please safely unplug the device as instructed at PC before removing the USB cable in case of loss of data.

1. Find the external device identification in the task bar at the bottom right corner of PC.
2. Right click to select Unplug ME65 Device.
3. Carefully remove the USB cable.



## Power off

### Method 1

1. Long press the power key and wait for a popup dialog box.
2. Tap the power off option.

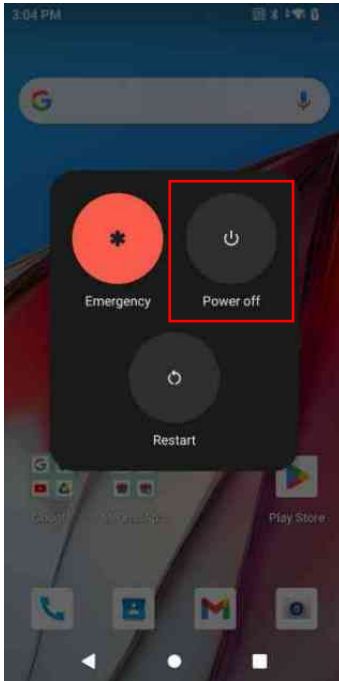

### Method 2

1. Open the Quick Access Panel, scroll down, click "⏻", and select power off.

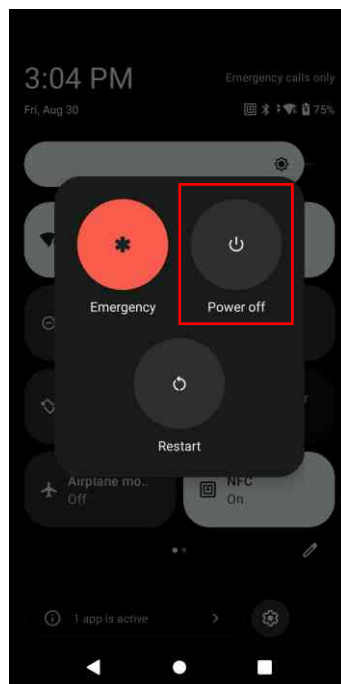
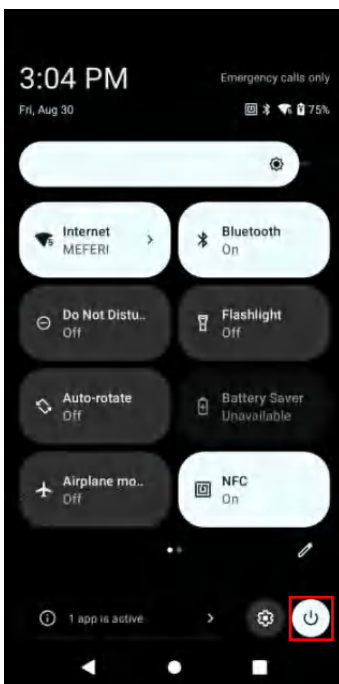

## Restart

### Method 1

1. If an app stops responding, long press the power key for hot reset.

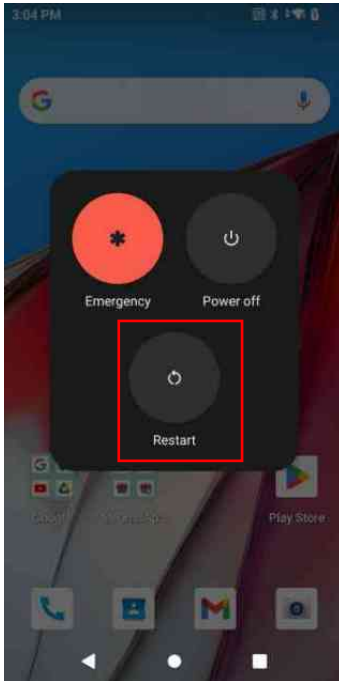

### Method 2

1. Open the Quick Access Panel, scroll down, click "⏻", and select Restart

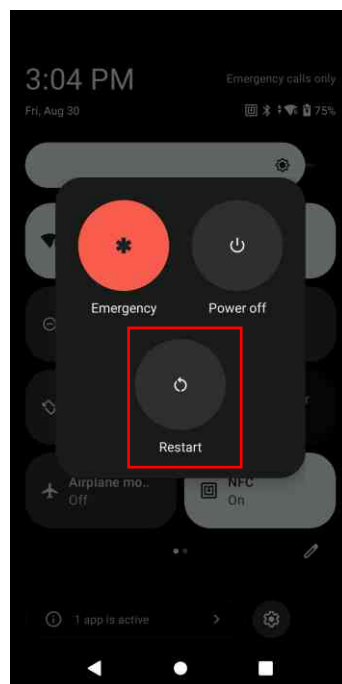
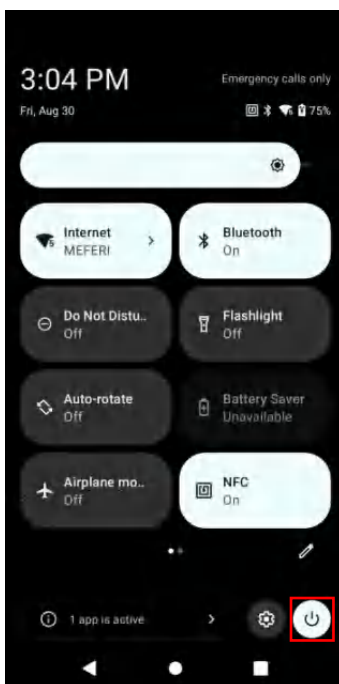

## Task Manager

1. Click the menu button on the right and the list below will appear

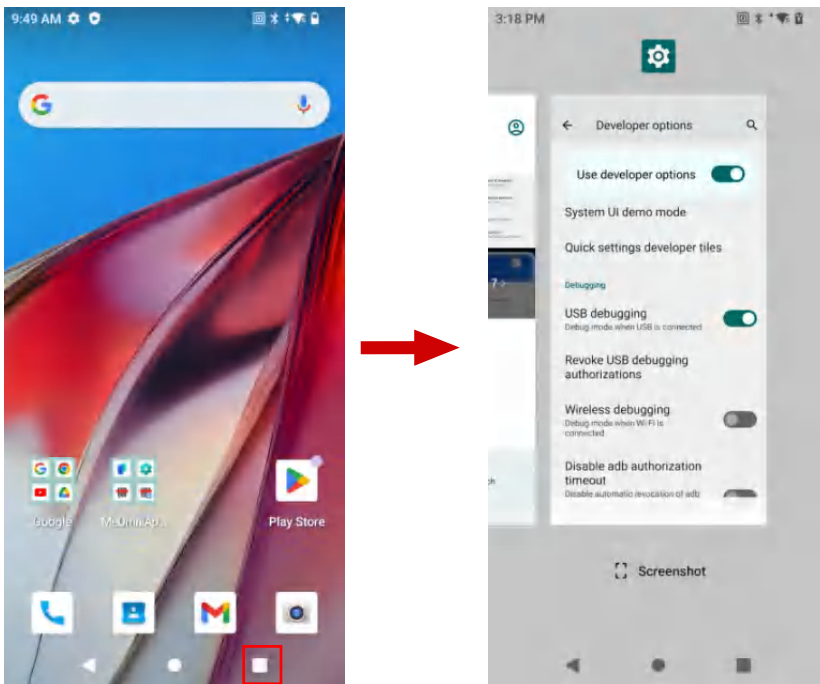

2. Slide left or right the screen to find any app accessed lately.
3. Slide up to clear apps lately accessed from the background.
4. Tap the "CLEAR ALL" to clear all the lately accessed apps from the background.
5. Tap apps to be switched to switch apps.

## About Device

Open Settings - "About phone" to view information of this Terminal Device.

- Model—view the device's model.
- Phone SN—display the device's unique identifier--SN.
- Android version—view the device's Android version.
- IP address—display the device's IP address.
- Wi-Fi MAC address—display the device's WIFI physical address.
- Bluetooth address—display the device's Bluetooth address.
- Build number—display the device's Build number.

## Upgrading

Local Upgrading--open Settings - "System" - "GuardForce" - Select Local Upgrade.

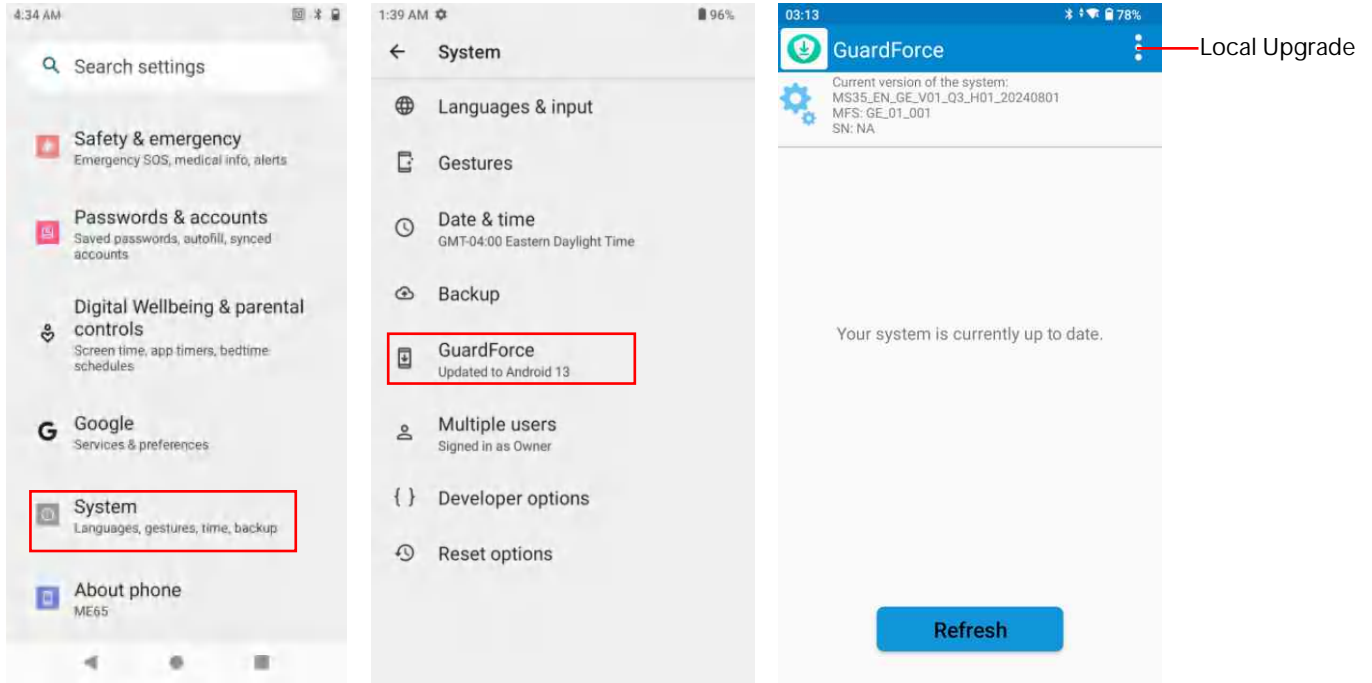

Remote Upgrading--open Settings - "System" - "GuardForce", For remote upgrading, please contact MEFERI's technical support team, And provide the device SN number and current version.

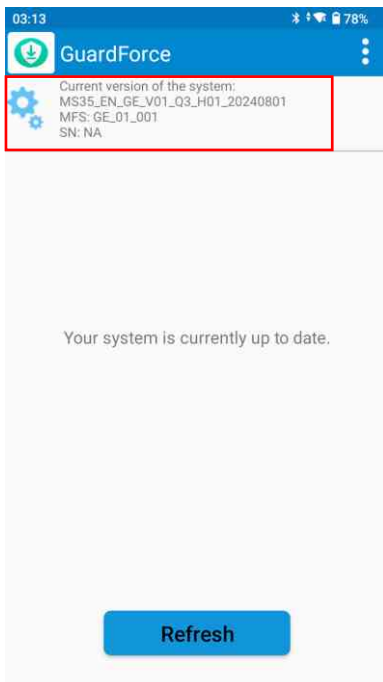

# Settings

## Introduction

This chapter describes the settings on the device.

## Accessing Settings

There are multiple ways to access settings on a device.

### Method 1

Swipe down from the top of the Home screen to open the Quick Access panel and touch "settings icon".

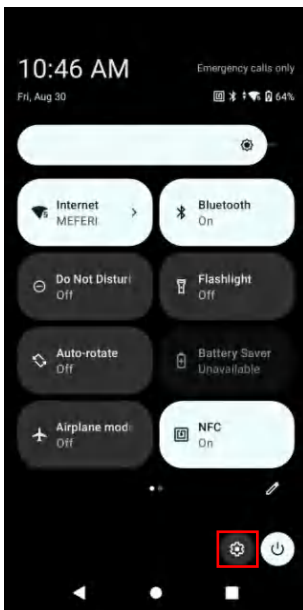

### Method 2

Swipe up from the bottom of the Home screen, touch "Settings APPS".

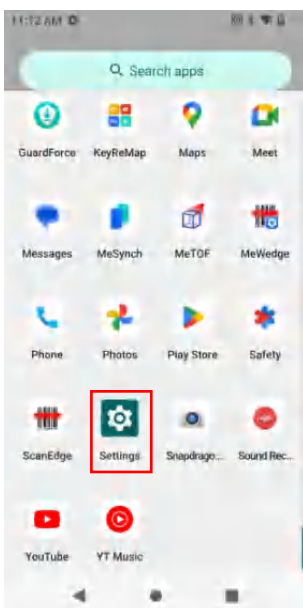

# Display Settings

## Introduction

Use Display settings to change the screen brightness, enable screen rotation, set sleep time, and change font size.

## Setting the Screen Brightness Manually

Manually set the screen brightness using the touchscreen.

### Method 1

1. Swipe down twice from the top of the Home screen to open the Quick Access panel and touch "☼"
2. Slide the icon to adjust the screen brightness level.

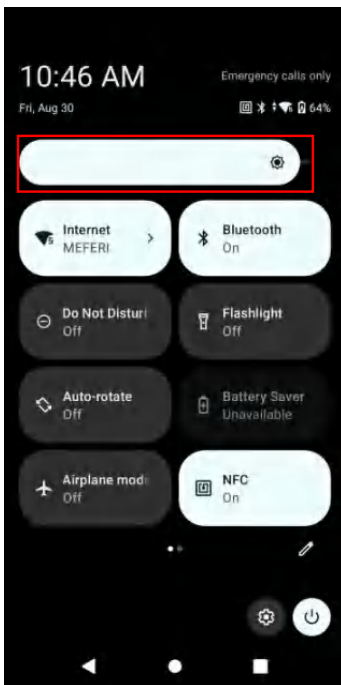

### Method 2

1. Swipe down from the top of the Home screen to open the Quick Access panel and touch "settings icon" or swipe up from the bottom of the Home screen, touch "Settings APPS".
2. Touch "Display".
3. Touch "Brightness level", slide the icon to adjust the screen brightness level.

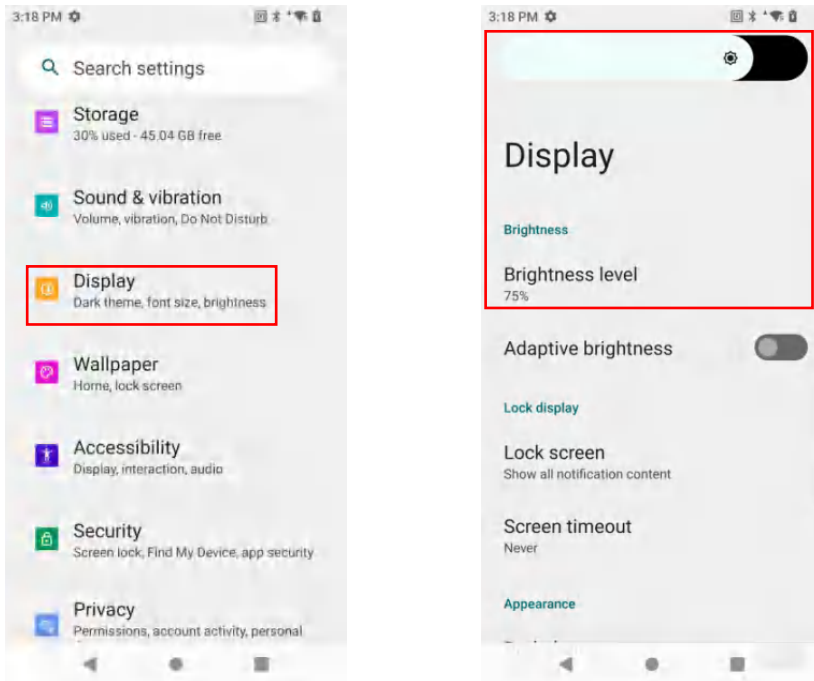

## Setting the Screen Brightness Automatically

Automatically adjust the screen brightness using the built-in light sensor.

1. Swipe down from the top of the Home screen to open the Quick Access panel and touch "settings icon" or swipe up from the bottom of the Home screen, touch "Settings APPS".
2. Touch "Display".
3. If disabled, touch "Adaptive brightness" to automatically adjust the brightness. By default, "Adaptive brightness" is enabled. Toggle the switch to disable.

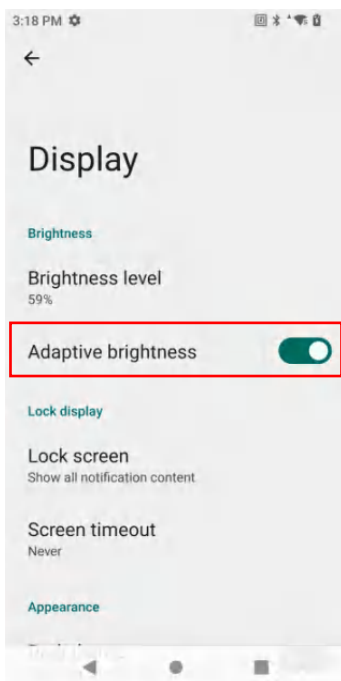

## Setting Screen Rotation

By default, screen rotation is off.

**NOTE:** To change the Home screen rotation, see Setting Home Screen Rotation.

1. Go to Settings.
2. Touch "Display".
3. Touch "Auto-rotate screen".

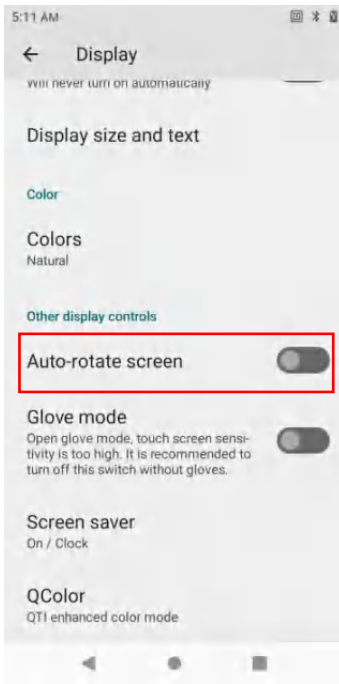

## Setting Screen Timeout

Set the screen sleep time.

1. Go to Settings.
2. Touch "Display".
3. Touch "Screen timeout", select one of the sleep values:
  - None (default)
  - 15 seconds
  - 30 seconds
  - 1 minute
  - 2 minutes
  - 5 minutes
  - 10 minutes
  - 30 minutes



## Setting Font Size

Set the size of the font in system apps.

1. Go to Settings.
2. Touch "Display".
3. Touch "Display size and text", you can set the font size or display size

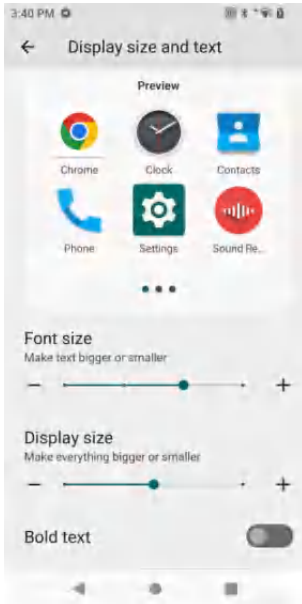

## General Sound Setting

### Introduction

Use the Sound settings to configure media and alarm volumes.

1. Go to Settings.
2. Touch "Sound & vibration".
3. Touch an option to set sounds.

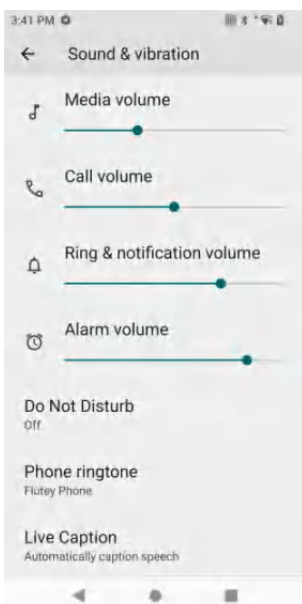

## Sound Options

- Media volume—Controls the music, games, and media volume.
- Call volume—Controls the Call volume.
- Ring & notifications volume—Controls the notification volume.
- Alarm volume—Controls the alarm clock volume.
- Do Not Disturb—Mutes some or all sounds and vibrations.
- Phone ringtone - Select a sound to play when the phone rings.
- Media—Shows the media player in Quick Settings while sound is playing, allowing quick access.
- Vibrations & haptics
  - Ring vibrations
  - Vibrate first then ring gradually
  - Notifications vibrations
  - Alarm vibrations
  - Touch feedback
  - Media vibrations
- Default notification sound—Select a sound to play for all system notifications.
- Default alarm sound—Select a sound to play for alarms.
- Touch sounds—Play a sound when making screen selections
- Charging sounds and vibration.

## System Settings

### Introduction

Use System settings to change the languages, set data & time, and factory reset.

### Changing the Language Setting

Use the Language & input settings to change the device's language.

1. Go to Settings.
2. Touch "System" > "Languages & input".

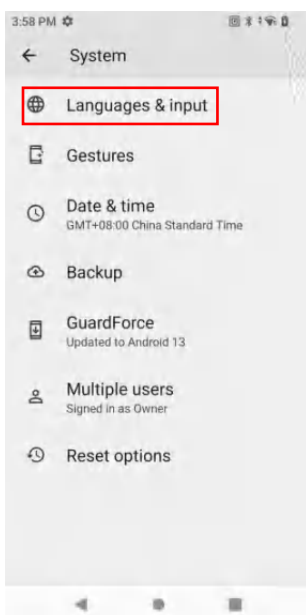

3. Touch "Languages". A list of available languages displays.
4. If the desired language is not listed, touch Add a language and select a language from the list.
5. Touch and hold to the right of the desired language, then drag it to the top of the list.
6. The operating system text changes to the selected language.

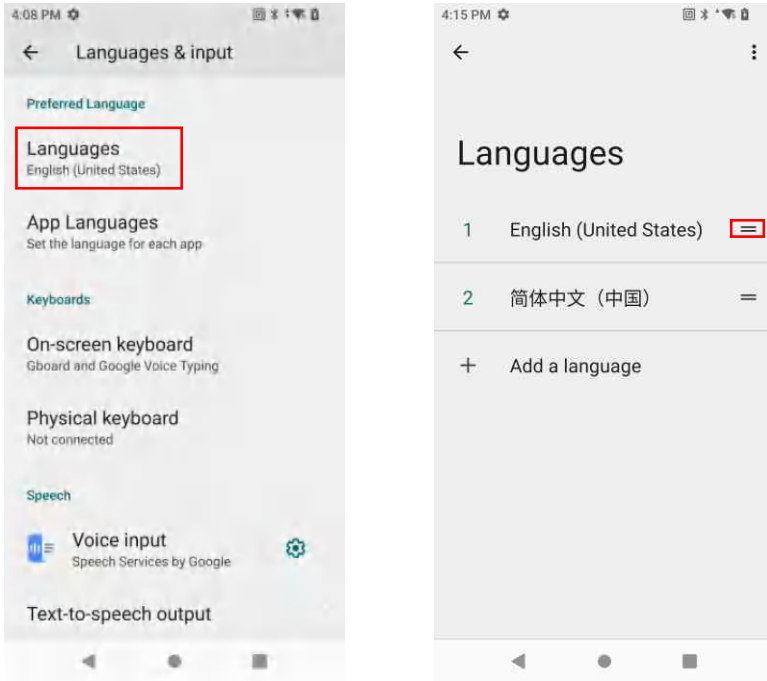

## Setting the Date and Time

You are only required to set the time zone or set the date and time if the wireless LAN does not support Network Time Protocol (NTP) or when not connected to a cellular/wireless network.

1. Go to Settings.
2. Touch "System" > "Date & time".

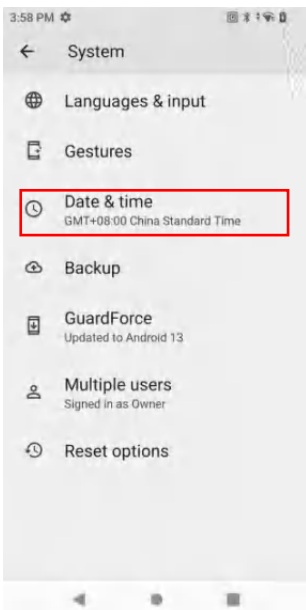

3. Touch "Date" to select the date in the calendar, touch OK.

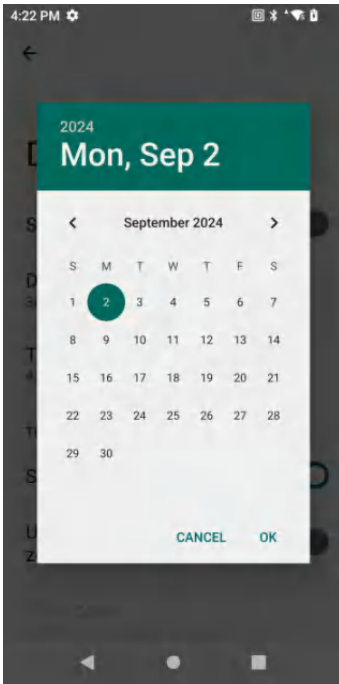

4. Touch "Time".

- a) Touch the green circle, drag to the current hour, and then release.
- b) Touch the green circle, drag to the current minute, and then release.
- c) Touch "AM" or "PM".

5. Touch OK.

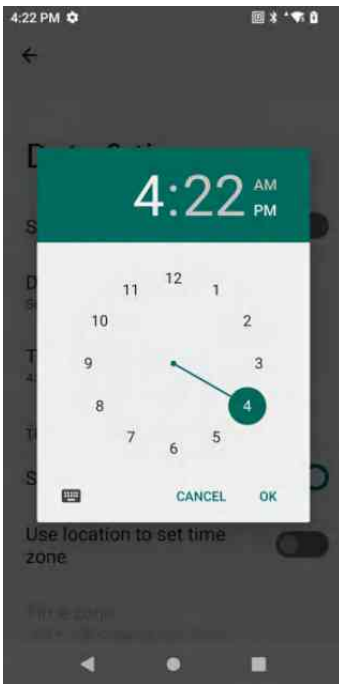

6. Touch "Use 24-hour format".

# Notifications

## Introduction

The user can configure notifications for the device and for specific apps. Device & app notifications settings allow the user to configure how notifications occur on the device. App settings allow the user to configure how notifications for a specific app occur.

1. To view Device & app notifications settings, touch Settings > Notifications > Device & app notifications.
2. To view app notifications, Settings > Notifications > App settings, and then select an app.

## Setting App Notifications

Configure the notifications settings for a specific app.

1. Go to Settings.
2. Touch "Notifications".
3. Touch "App settings" > See "All apps" . The App info screen displays.

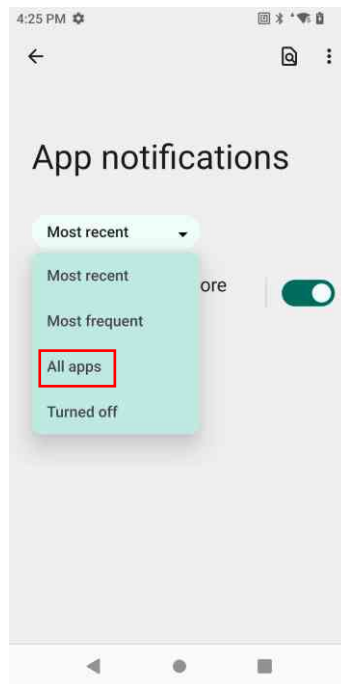
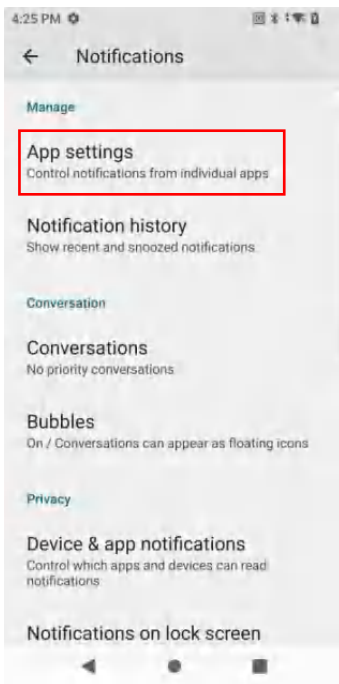

4. Select an app.
5. Touch "Notifications".

Options vary depending on the app selected.

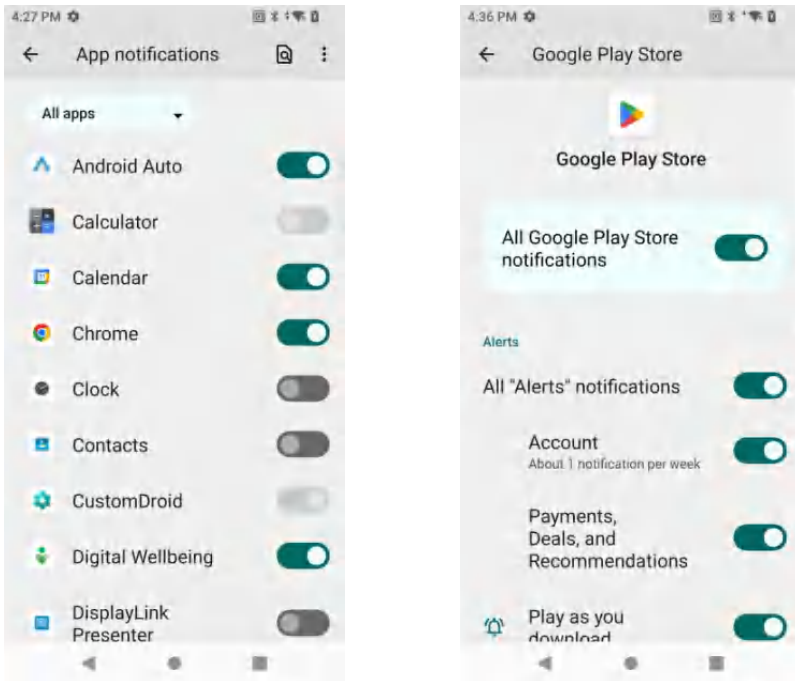

6. Select Setup: Show notifications - Select to turn all notifications from this app on (default) or off. Touch a notification category to display additional options.

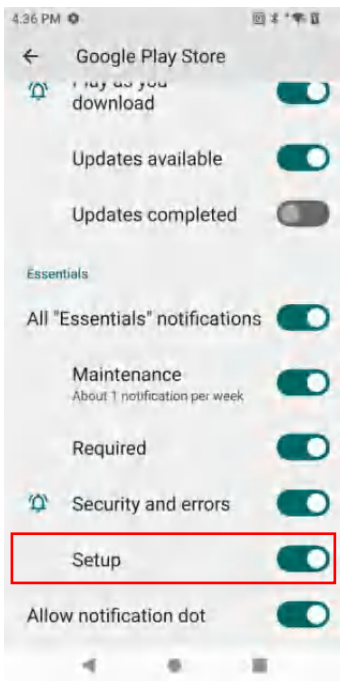

- Pop on screen - Allow notifications from this app to pop notifications on the screen.
- Sound - Allow notifications from this app to make sound.
- Vibrate - Allow notifications from this app to make vibrate the device.
- Blink light - Allow notifications from this app the light the Notification LED.
- Show notification dot - Allow notifications from this app to add a notification dot to the app icon.
- Override Do Not Disturb - Let these notifications continue when Do Not Disturb is on.

- Silent - Do not allow notifications from this app to make a sound or vibration.
- Minimize - In the Notification panel, collapse notifications to one line.

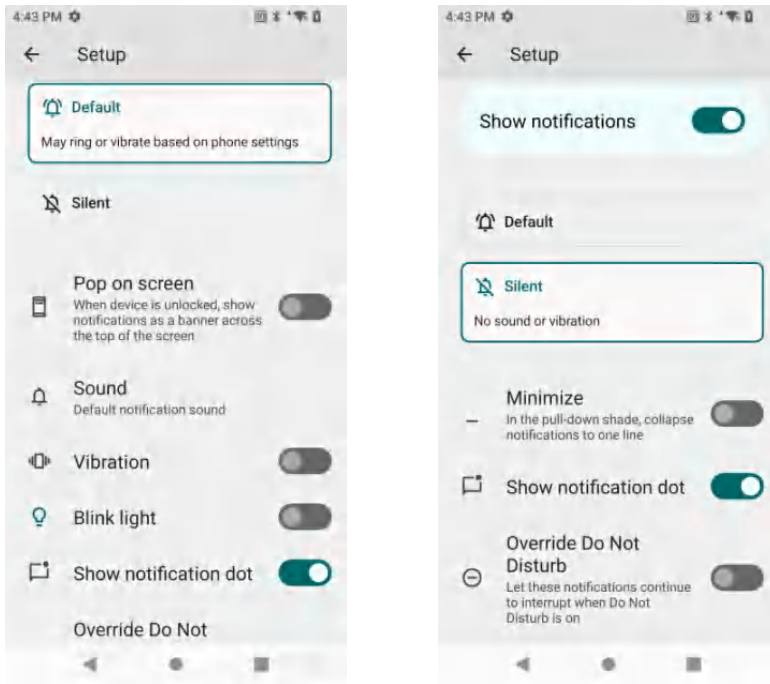

## Controlling Lock Screen Notifications

Control whether notifications can be seen when the device is locked.

1. Go to Settings.
2. Touch "Notifications".
3. Touch "Notifications on lock screen" and select one of the following:
  - Show conversations, default, and silent.
  - Hide silent conversations and notifications.
  - Don't show any notifications.

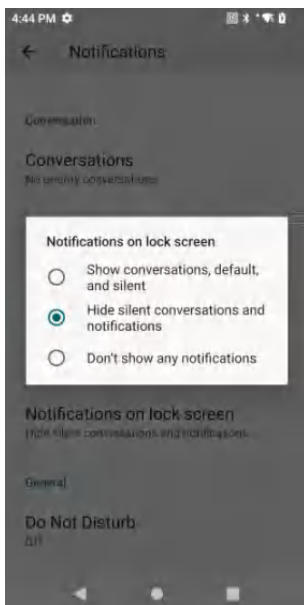

# Applications











## Introduction

Apart from the standard pre-installed Android applications, the following table lists MEFERI-specific applications installed on the device.

## Installed Applications

Icon	Description
	Calculator - Provide basic and scientific calculating functions.
	Calendar - View and manage calendar events.
	Camera - Take photos and record videos.
	Chrome - Access the network.
	Clock - Set the alarm and timer.
	Contacts - Manage contact information.
	Drive - Cloud Drive to store files
	Files - Organize and manage all the files in the device.
	Gmail - Receive and send e-mails.
	Google - Search engine.
	Google TV - Google smart TV
	Map- View satellite maps, public transport and driving directions.
	Meet - Videoconference.
	Messaging - Receive and send SMS and MMS.
	Phone - Dial a phone number for voice communications.
	Photos - View or edit photos in the device and microSD Card.
	Play Store - Download apps developed with the Android SDK and distributed by Google.
	Settings - Configure ME65.
	Sound Recorder - Record audio files.



	YouTube - Upload original content and share your videos.
	YT Music - Play audio files online or stored on your device.
	MeSynch - Enables to copy device settings to other devices with just one scan of a barcode.
	MeWedge - Configures a set of scanning head parameters for each application.
	ScanEdge - Configures the settings of the scanning head parameters.
	CustomDroid - Installing your custom functions for the Android OS.
	KeyReMap - creates and adjusts the keyboard to your requirements
	Safety - Safety settings (Emergency SOS, Emergency sharing, etc).
	GuardForce - Android provides regular updates with the latest security patches
	eSIM Toolkit - Can be used as a SIM card, no need to insert the card.
	MeTOF - See the Unseen. Rethink objects Measurement

## Accessing Apps

Access all apps installed on the device using the APPS window.

1. On the Home screen, swipe up from the bottom of the screen.
2. Slide the APPS window up or down to view more app icons.
3. Touch an icon to open the app.

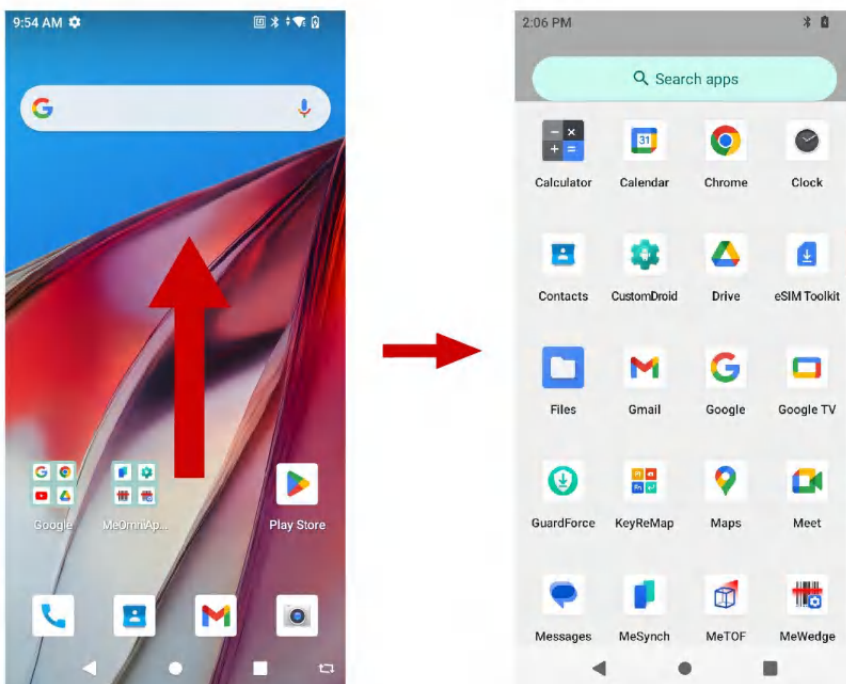

## Switching Between Recent Apps

1. Touch Menu "☰".
2. Slide left or right the screen to find any app accessed lately.
3. Slide up to clear apps lately accessed from the background.
4. Tap the "CLEAR ALL" to clear all the lately accessed apps from the background.
5. Tap apps to be switched to switch apps.

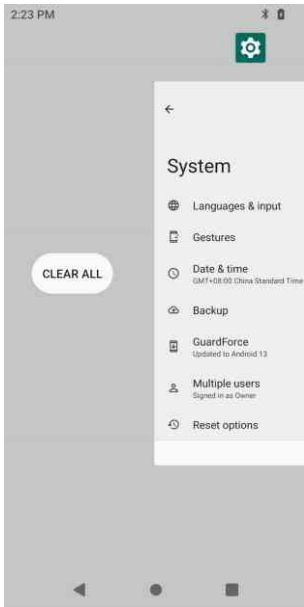

## Key Mapping

Key mapping applies to all the physical keys except the power key. Each mapped key can be granted with a new key value.

Steps for key mapping:

1. Open KeyRemap.

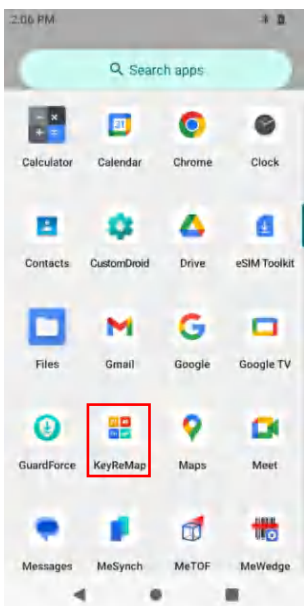

2. Select any physical key - Replace by a new key, press the physical key for key mapping, the key value and name will be shown.

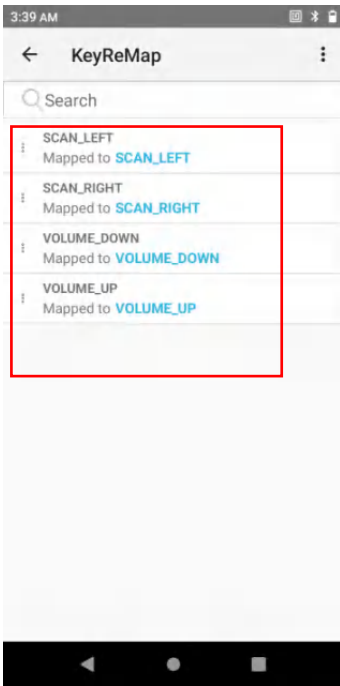

3. For example, select the "VOLUME\_DOWN" key.



Key Mapping Function 1

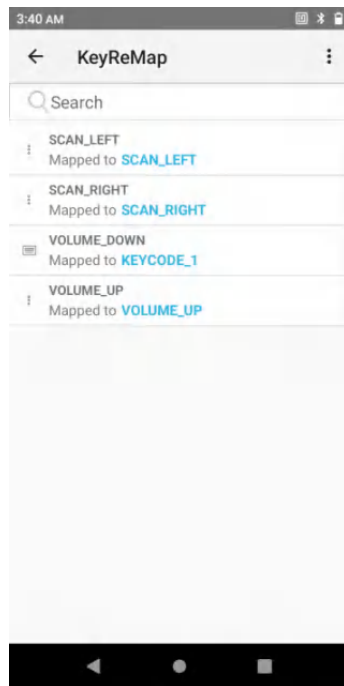

Key Mapping Function 2

4. Select any physical key - Replace with App, press the physical button to map the button, and select APP.

5. For example, select the "SCAN\_LEFT" key.

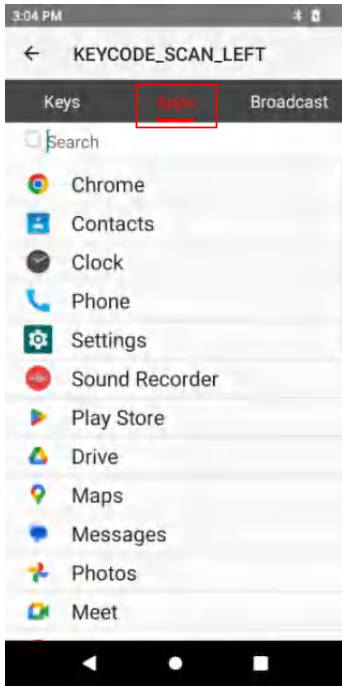

APP Mapping Function 1

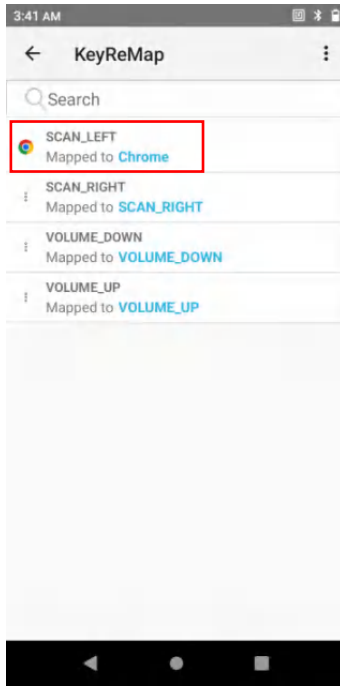

APP Mapping Function 2

6. Select any physical key - replace with broadcast, press the physical button to map the button, select broadcast, edit the content, and click Save.

7. For example, select the "SCAN\_RIGHT" key.

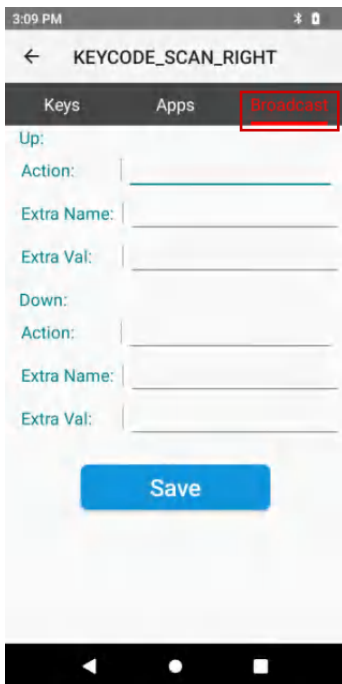

Broadcast Mapping Function 1

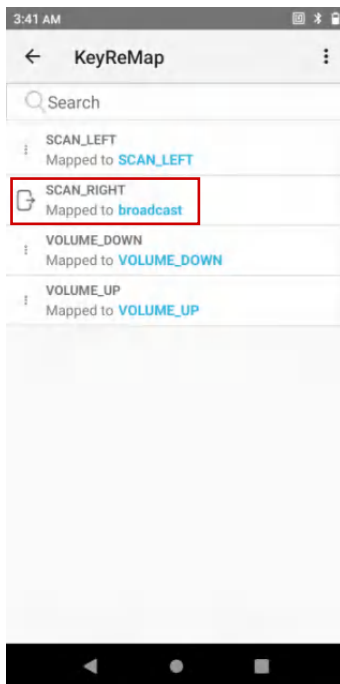

Broadcast Mapping Function 2

## Manage key Mappings

### Delete key Mapping Settings

Slide a certain option in the list to the left to reset the key to the default settings and clear the key's mapping value;

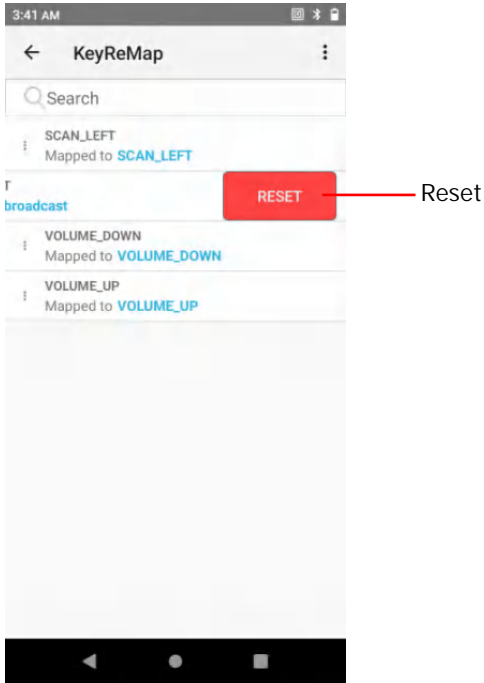

### Reset Mapping Key

Touch the menu key at the top right corner to clear the value of each mapped key and restore the default value of each physical key.

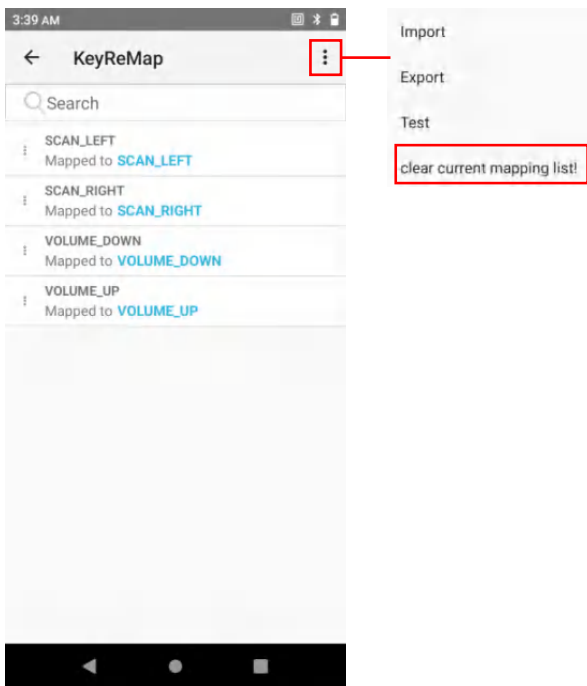

## MeTOF Operation Method

1. Before collecting, please observe the camera lens to ensure that it is free of dirt, fingerprints, etc.



2. Open MeTOF.

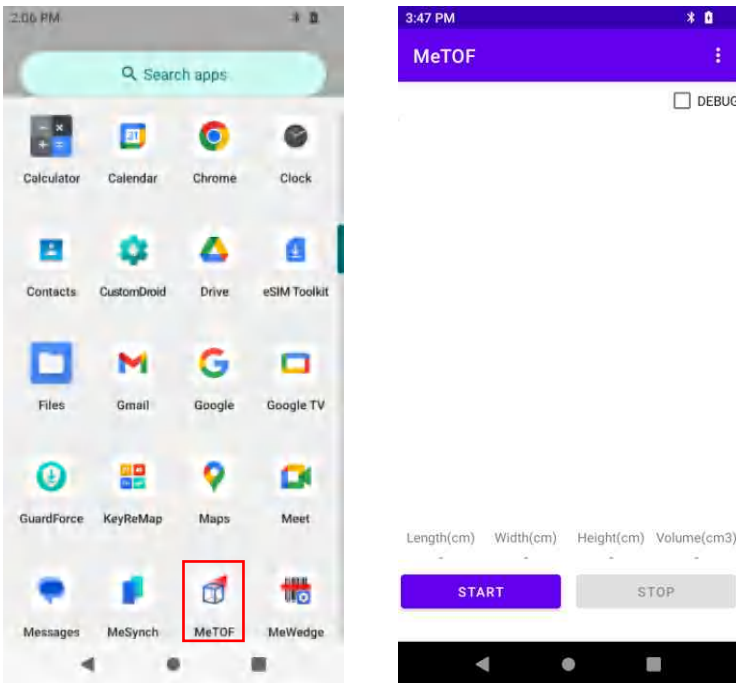

3. The MD Client provides a sample user interface (UI) that allows end-users to perform dimensioning capture and view the dimension results.

The MD Client is an example of a line-of-business customer app and may only be used for demonstration and testing of the dimensioning solution.

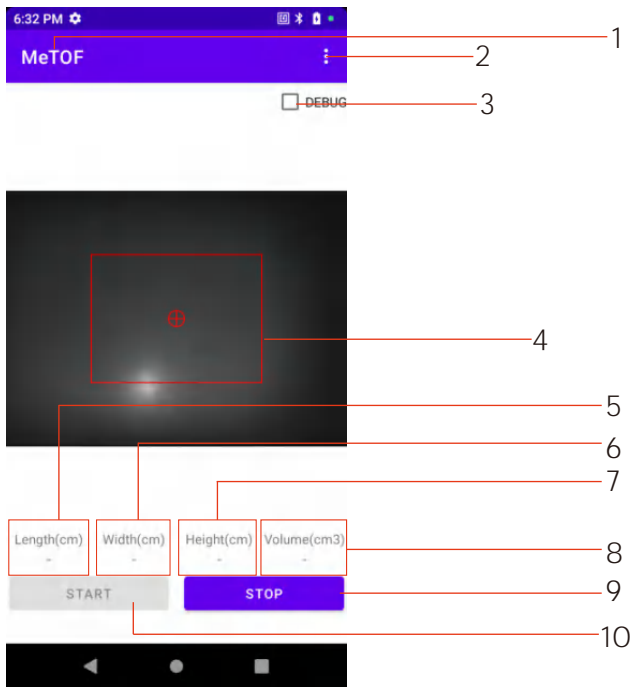

1	APP name
2	More menus to display the app version
3	Debug switch
4	Measurement frame. When measuring, place the object to be measured in the red frame and aim the crosshair at the top of the object.
5	Display the length of the measured object
6	Display the width of the measured object
7	Display the height of the measured object
8	Display the volume of the measured object
9	Stop button
10	Start button, click to start measurement

4. Please make sure that the marked point in the center of the image is on the top surface of the cube package being tested, and observe whether the package prompt box appears in the image and fits the actual edge of the package being tested.

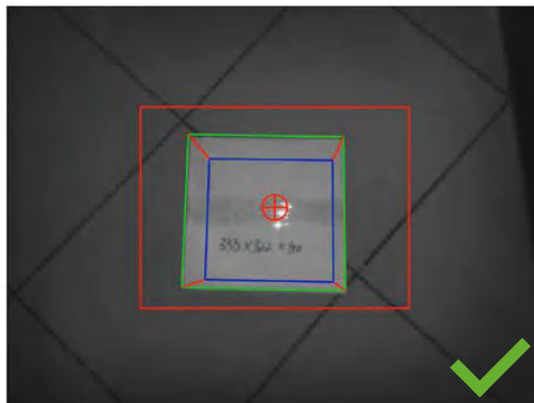
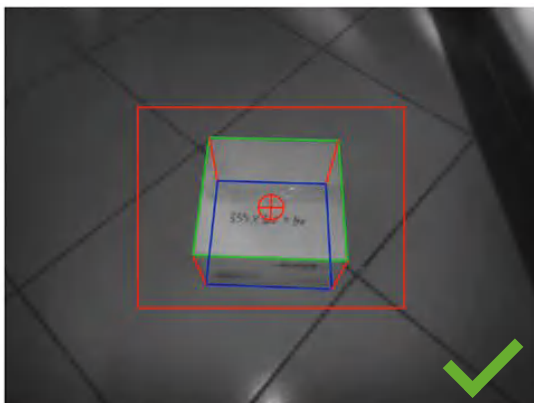

5. When the above conditions are met, click the "STOP" button to complete the collection measurement, and the page displays the volume value of the box.

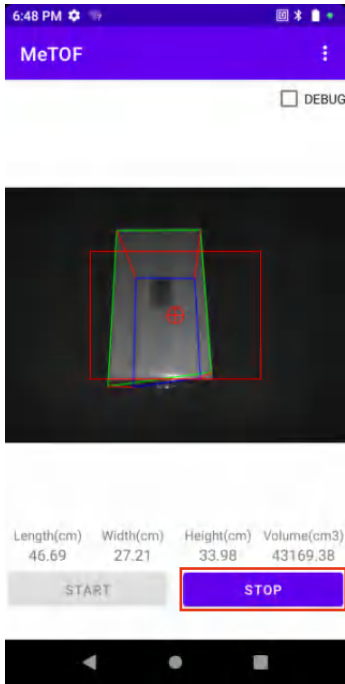

6. The following illustrations show unsupported cabinet aiming methods. Please avoid:



The marker point is not on the top of the box



The box exceeds the package prompt box

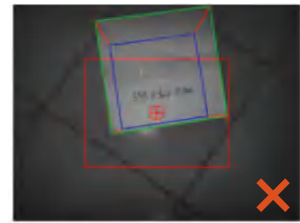

7. If the edge frame of the package being measured is skewed in the image, please manually click to abandon the measurement results and switch the angle to measure again;

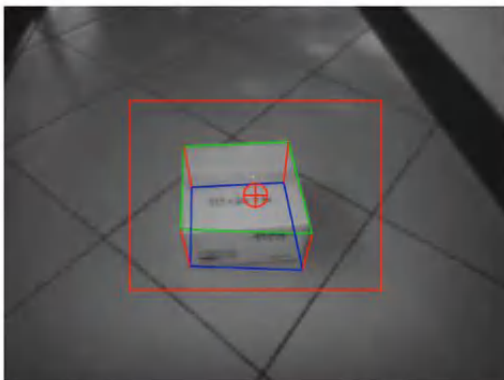



## Dimension Capture

For the optimal dimension capturing experience, the following sections provide information about dimensioning use cases, aiming methods, tips, and limitations of the framework.

### Parcel Use Cases

1. The MEFERI parcel dimensioning solution only supports cuboidal parcels placed on a flat surface.

#### Supported Parcels

Figure 1 Examples of objects that support volume measurement.

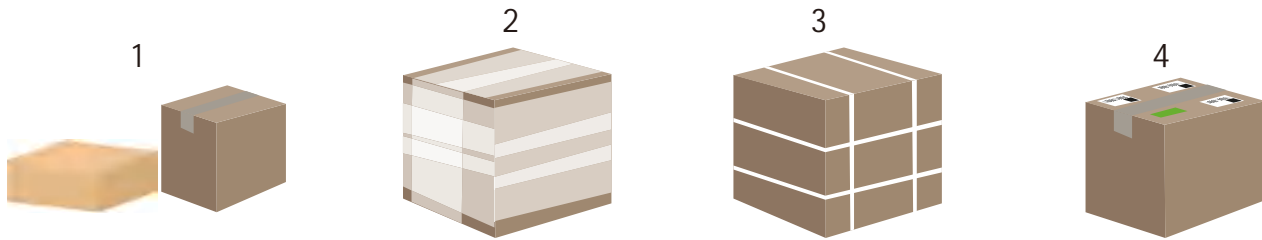

Figure 1

1	Regular cuboid (cardboard, wood, plastic)	2	Stretch film wrapped box
3	Boxes tied with packing tape	4	Boxes with tape or labels on the surface

#### 2. Unsupported Parcels

Figure 2 Examples of objects that Unsupported volume measurement.

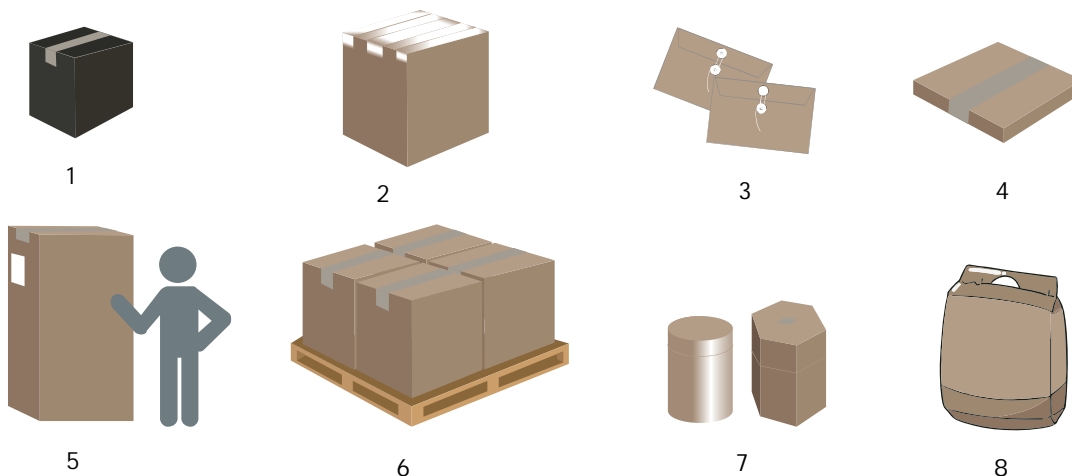

Figure 2

1	Black wrap or parcel Non-reflective surface	5	Extra large boxes, such as air conditioner packaging boxes or TV boxes, etc.
2	Enclosures that wrap transparent surfaces or mirrored or highly reflective surfaces	6	Palletized freight
3	Ultra-flat packages, such as envelopes, document bags, etc.	7	Non-cuboidal
4	Flat carton box	8	Non-cubic irregular shaped packages, such as bags of rice

## Dimension Aiming Methods

For the optimal dimensioning results, always make sure that the entire parcel is visible in the Viewfinder.

### 1.1 Use height requirements

Adjust the measuring height according to different package sizes, keeping the measuring height between 0.4-1.4m.

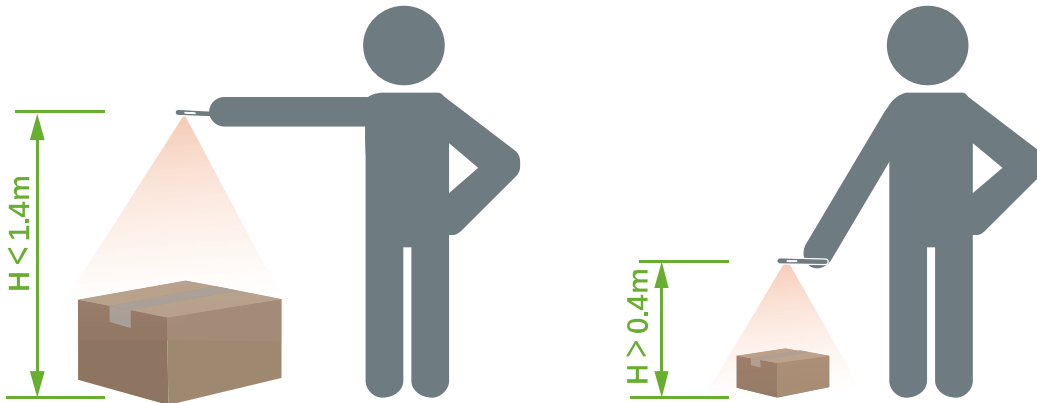

### 1.2 Usage angle requirements

It is recommended that the search angle be within the range of 0°~50° when used.

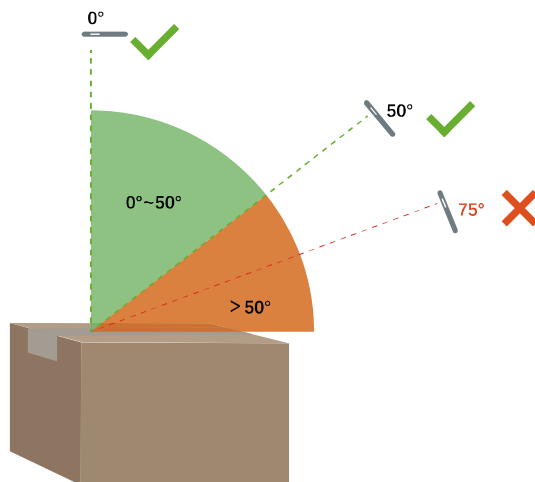

### 1.3 Box placement requirements

A: Depending on the size of the box, the box can be placed on the ground or on the table for overhead or squinting measurements; there should be an open area of 20cm around the box to avoid other influences.

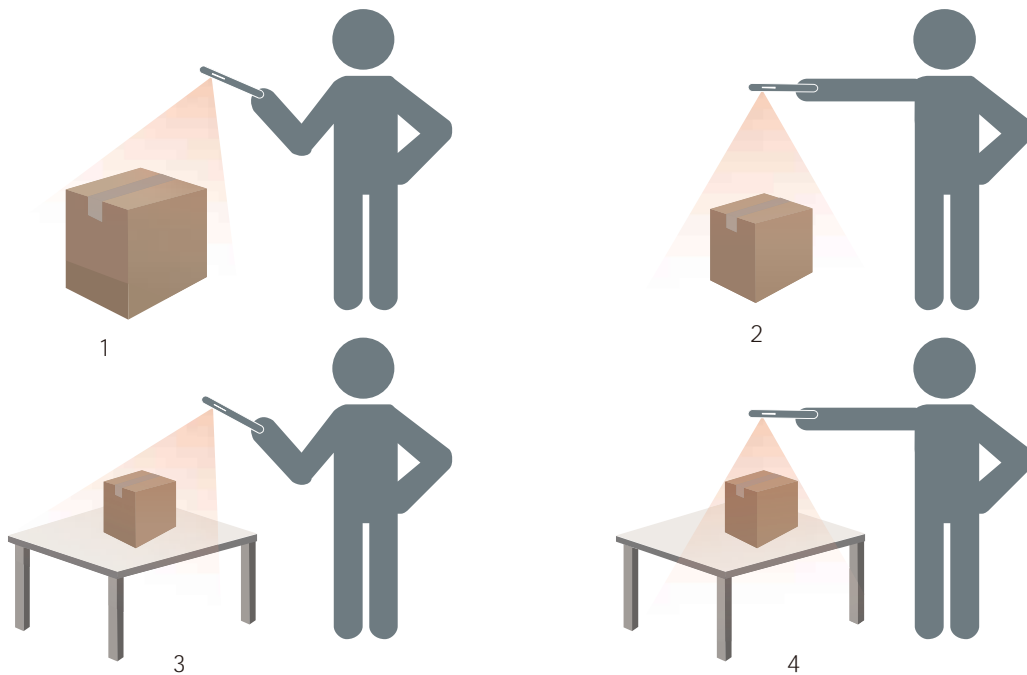

1	Angled view on floor	3	Angled view on countertop
2	Top-down view on floor	4	Top-down view on countertop

### Angled Method

When a top-down view of the parcel is not possible, dimensioning can be performed using an angled method. For this method, it is preferred to aim the viewfinder at an angle that captures the top and one full side of the parcel.

- Place the on-screen aimer on the top surface of the parcel while keeping the entire parcel visible in the Viewfinder.
- Make sure that there is a minimum of 20 cm (7.9 in.) of floor or counter space around all visible sides of the target parcel.

B: If you want to place the package on the desktop for measurement, please ensure that the desktop occupies more than 90% of the area on the collection page.

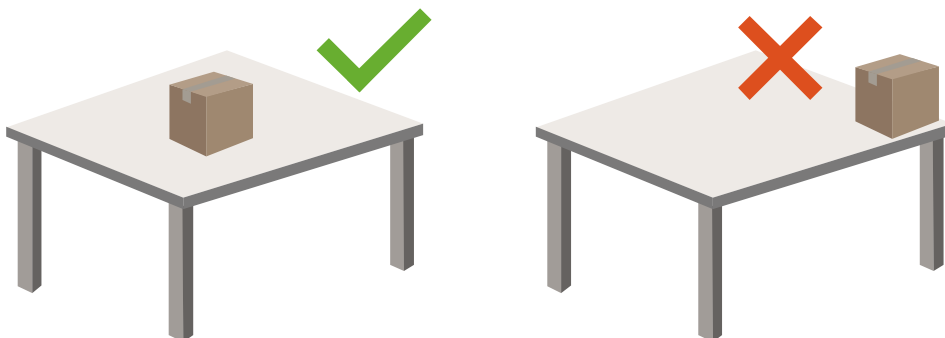

C: Do not hold the package in hand, place the package in the corner, or raise the package for measurement.

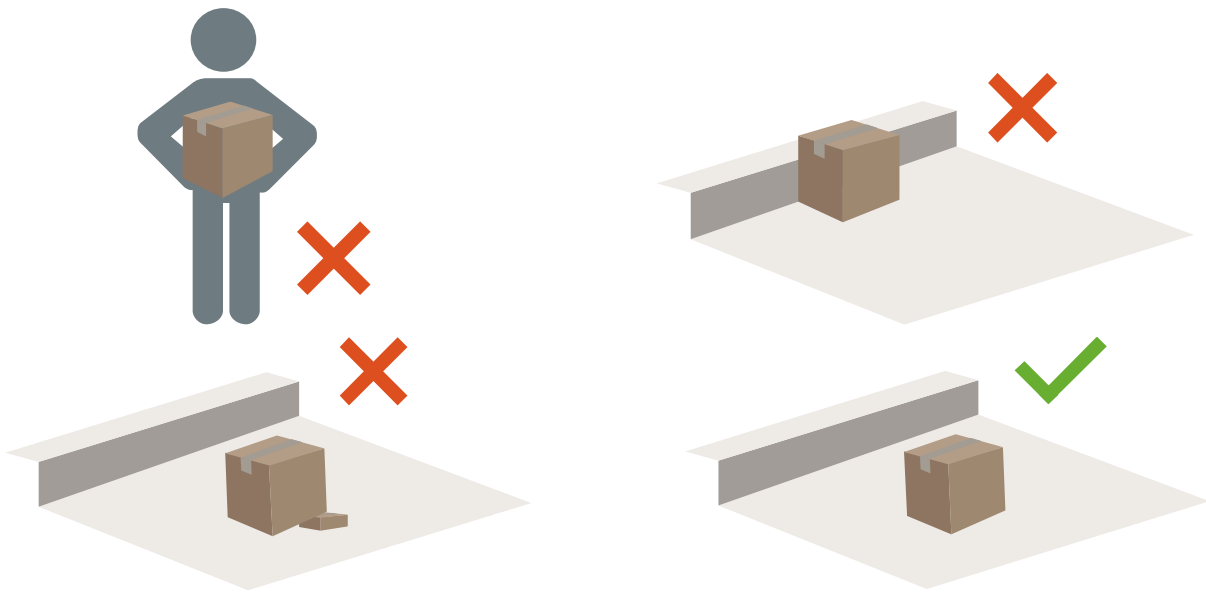

D: It is recommended that no other boxes appear in the search range in the test environment, otherwise it may affect the measurement accuracy.

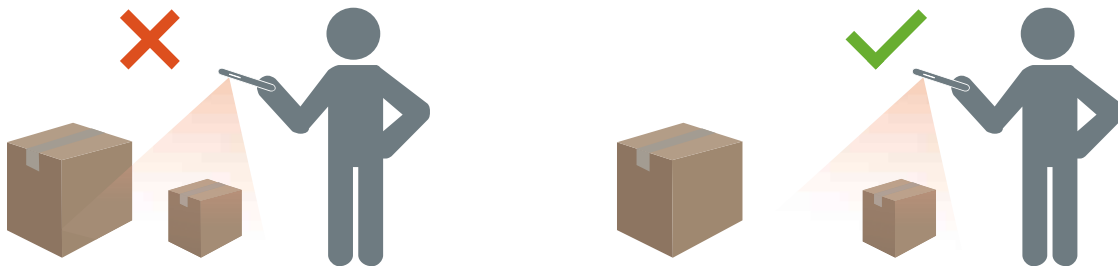

**E: Dimensioning with Multiple Devices**

When using multiple devices to perform dimensioning in close proximity, make sure not to overlap the field-of-views.

As part of the dimensioning process, the TOF camera uses illumination that is not visible to the naked eye. No dimensions are captured when the illumination coming from two or more nearby devices overlaps.

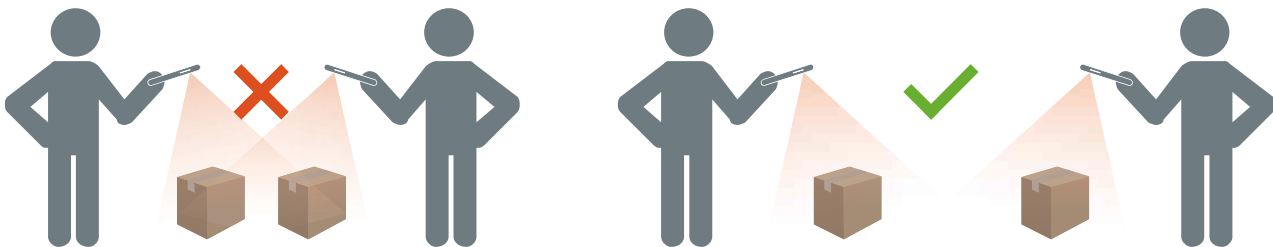

F: Try to keep the handheld device as stable as possible during the measurement process to avoid shaking that affects the measurement results.

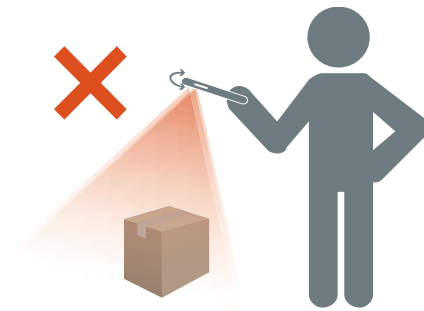

G: Avoid measuring in environments that are too bright, have high ground emissivity (mirror or glass), and have low ground reflectivity (black paint), so as not to affect TOF sensor performance.

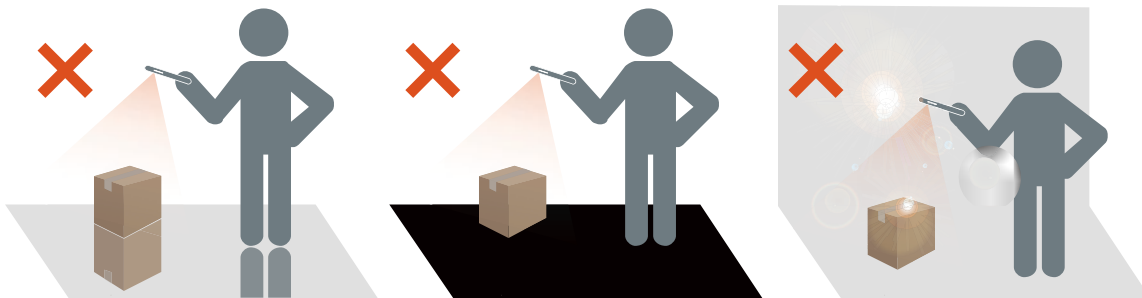

### Tips for Optimal Dimensioning

To optimize your dimensioning performance, follow these recommended tips.

#### Minimum Range

It is recommended that the distance to a parcel be at least 40 cm (16 in.).

This is important when dimensioning small boxes. If aiming top-down at close range there may be too much IR glare directed at the dimensioning device. It is visible on the display as a light colored area. When this happens, tilt the dimensioning device slightly to move the glare off of the parcel's top surface.

The glare spot is easily visible in the first image below. The second image shows the result of tilting the dimensioning device.

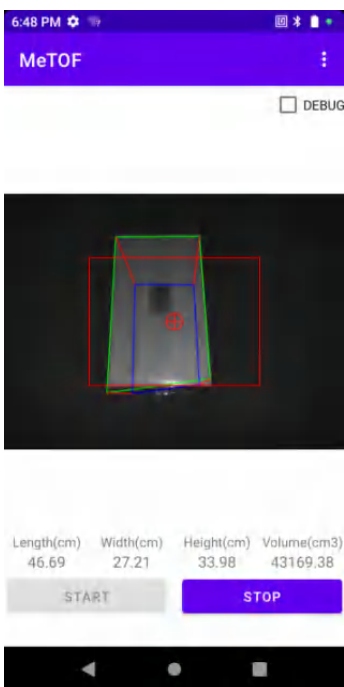

## Limitations

The dimensioning framework can handle a wide range of parcels, with the following limitations.

### Black Surfaces

The 3D sensor cannot reliably detect black surfaces. Under the following conditions, parcel dimensioning attempts timeout to a NoDim (no dimension) result.

- Black parcels - This includes parcels wrapped in black material.
- Black floor - The floor must be recognized for dimensions to be calculated.

Dimensioning on grey surfaces, such as asphalt, should be possible even in sunny conditions.

- Black tape - This applies to black tape on the top edges of the parcel. You can dimension parcels with black tape across the middle by making sure the aimer is not on the black tape. If the aimer is on the black tape, the parcel may not be dimensioned.

### Highly Reflective Surfaces (Specular Reflection)

The 3D sensor cannot reliably dimension with highly reflective surfaces such as shiny metal walls or mirror-like reflective surfaces that produce a specular reflection.

The user must dimension the targeted parcel with these surfaces outside the field-of-view of the camera (i.e., not within the viewfinder display).

- Shiny metal walls and floor – mostly unpainted bare metal that produces a mirror-like reflection
- Shiny containers – metal containers next to the target parcel
- Mirrored walls
- Metal tape – this applies to metal tape on the visible surfaces or edges of the parcel.

### Long or Thin Parcels

Parcels where one dimension is near the maximum and one dimension is near the minimum may lead to a NoDim (no dimension) result. For example, a parcel measuring 100 x 15 x 15 cm may not produce a dimensioning result. However, a parcel measuring 50 x 15 x 15 cm should produce a result.

### Directional Feedback

To receive directional feedback, the dimensioning service must be able to identify that there is a parcel in the field-of-view.

- If the device is too close to the parcel, move further away until the entire parcel is visible in the Viewfinder. The ToF camera cannot dimension a parcel closer than the minimum range of the ToF camera. Also, when the device is too close to the parcel, it can cause glare, which can interfere with dimensioning.
- If the device is too far from the parcel, move closer and fill more of the display area with the parcel.
- If the dimensioning angle is too steep, move or tilt the device to keep the angle within 50° of the top-down (0%) position. The device provides tilt feedback when the angle is too steep.

## MeMobilityDesk WorkStation

A Comprehensive and Integrated Mobile Workspace.

1. Our solution comprises the robust ME65 Mobile Computer, the innovative MeScreen Software, and a versatile MeMobilityDesk WorkSpace Cradle. Together, these elements usher in a New Era of Mobile Computing, offering desktop-like features and capabilities in a mobile device.

MeMobilityDesk WorkSpace Cradle

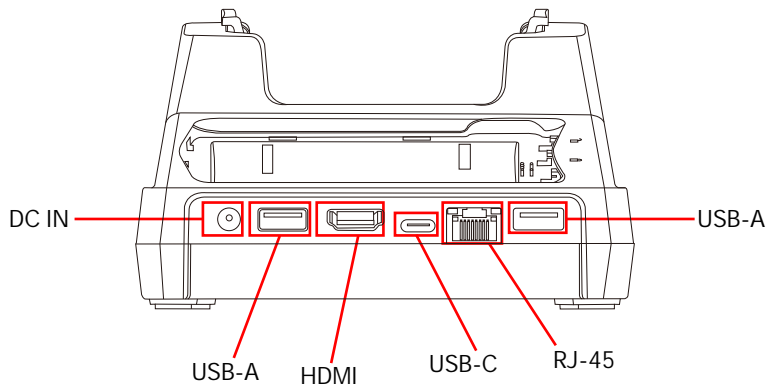

- DC IN - Power supply.
- USB-A - Connect mouse/keyboard.
- HDMI - Connect computer monitor.
- USB-C - Data transmission.
- RJ-45 - Connect network.

2. Connect the 12V/2A charger to the DC interface located on the back of the MeMobilityDesk WorkSpace Cradle.

3. Connect the cradle to any HDMI LCD monitor using an HDMI cable.

4. Attach the two USB-A interfaces to a mouse and keyboard or use Bluetooth. Connect the cradle via the Ethernet interface to a network cable, or use Wi-Fi/4G/5G on the ME65.

5. ME65 device into the MeMobilityDesk WorkSpace Cradle. The device and battery can also be charged while using desktop mode.



# Data Capture

## Introduction

ME65 supports data acquisition in the following methods.

- Scan engine decoding.

## Scan engine

- 2D scan engine can read various 1D/2D bar codes and 360° read various bar code systems, including the most prevalent linear bar code, postal code, PDF417, QR, DATAMATRIX, etc.
- By scanning techniques, 2D scan engine takes a photo for a bar code, saves the generated image in memory, and executes a top software decoding algorithm to extract bar code data from the image.

## Scan Settings

1. ScanEdge: can be tested and set, this setting is for the scan head.
2. Mewedge: scan settings for a certain application, for example: open continuous scanning in a certain APP, continuous scanning does not work outside this APP, only in the APP.

### Method 1-ScanEdge

1. In the home screen, pull up the screen to enter the app center interface, Select ScanEdge.

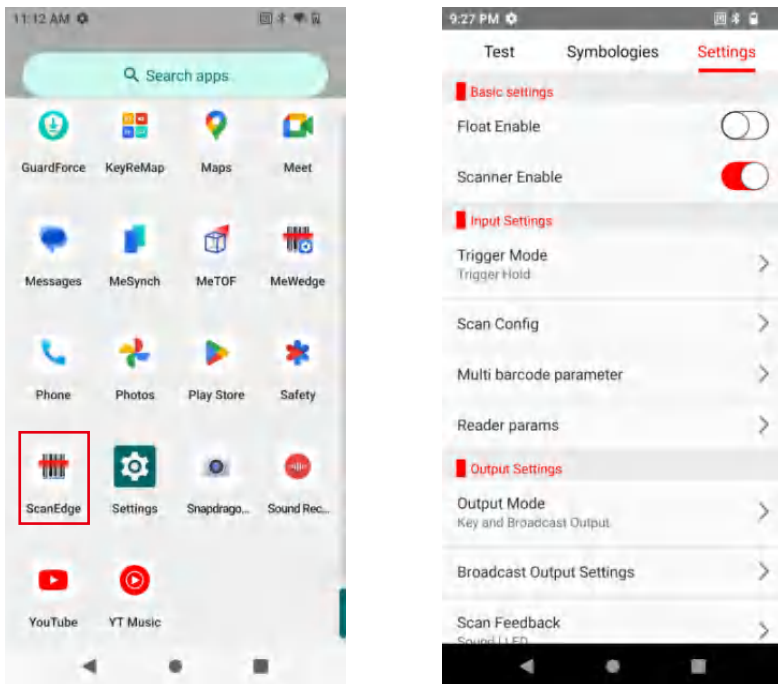

### Method 2-Mewedge

1. In the home screen, pull up the screen to enter the app center interface, Select Mewedge.



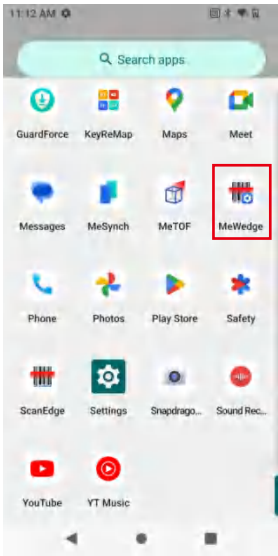

2. Create a new one and select the APP you want to set up.

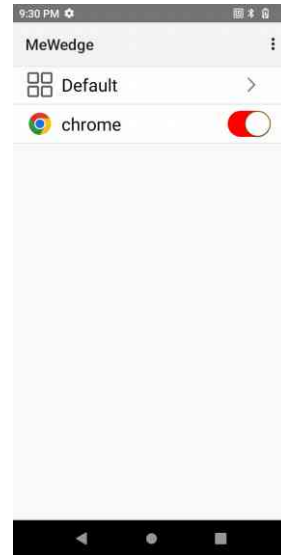
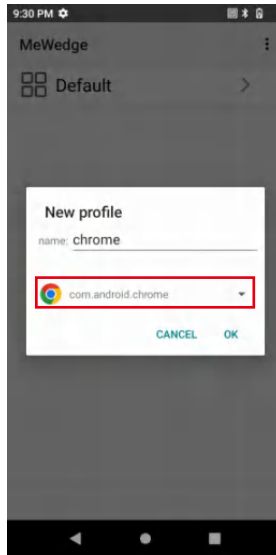
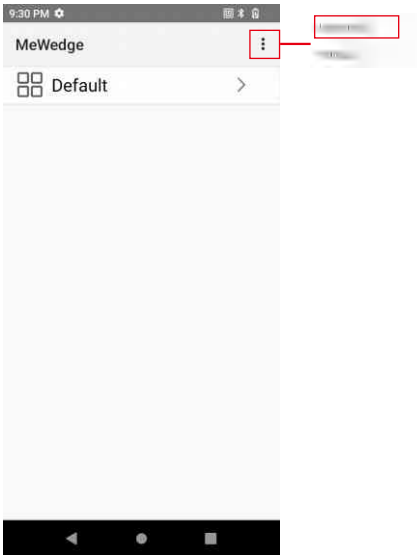

3. Apply scan settings.

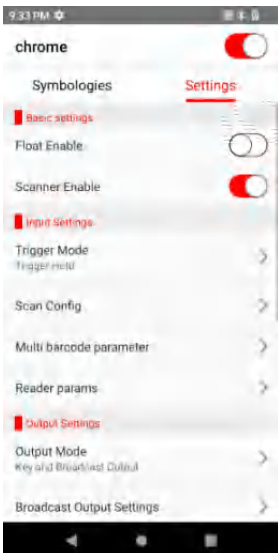

## Floating Action Button

Open the virtual key scanning tool on the desktop, which is available for dragging at will and touching to simulate the key scanning function.

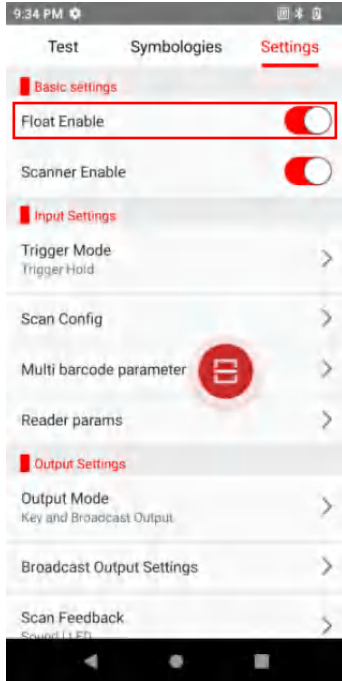

## Trigger Mode

- Auto mode - manually trigger the scanning function. Press the scanning key and laser light or supplementary light will be shown. The light will not go out until decoding is completed or scanning times out.
- Continuous mode - manually trigger the scanning function. In the continuous scanning mode, the scanning laser or supplementary image light will not go out after decoding. Instead, decoding will sustain.
- Manual mode - manually trigger the scanning function. Press the scanning key and laser light or supplementary light will be shown. Release the key and the light will go out. In addition, the scanning light will also go out after decoding.

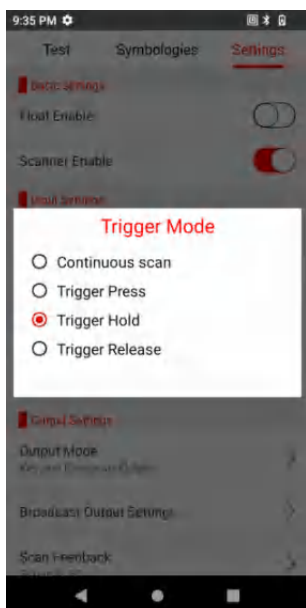

## Output Mode

1. Broadcast Output.
2. Key Output.
3. Key and Broadcast Output.

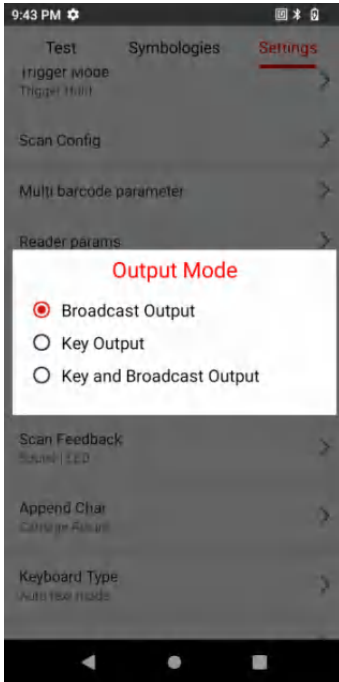

## Broadcast Output Settings

Set broadcasting via a corresponding app to receive tag and motion data of the designated broadcast. If the scanned data match the app's broadcast tag and motion (tag and motion are editable), the data will be directly received by the Broadcast Receiver. Any intent transfer value may be separately output or handled in the background.

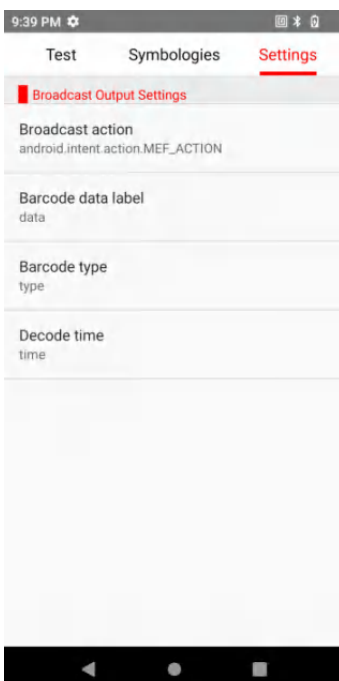

## Output by keyboard

Check this mode and the scanning results will be output to the app focus edit box in the foreground by keyboard. Cancel checking this mode and output will be done by broadcast.

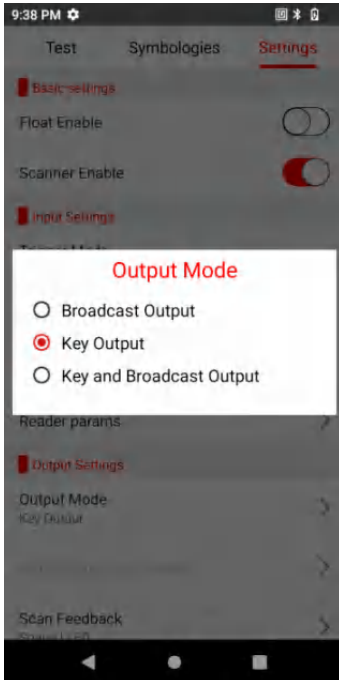

1. Keyboard Type - include Auto text mode, Soft keyboard, always use simulated keystrokes, may result in different scanning results, so please choose with caution.

- Soft keyboard - If a focus input box arises in any app interface in the foreground, it will directly show all the data, otherwise the device will output scanning results character by character through keyboard simulation.
- Auto text mode - the device directly displays all the data in the input box through input method editor simulation.
- Soft keyboard only: the device outputs scanning data through Soft keyboard event simulation at any interface.
- Always Auto text mode: output through any non-Android input box, e.g., webpage or search box.

2. Sound Feedback - set the system's notification tone for scanning, which may be LED, Vibrating or Sound.

3. Append Char - None, Carriage return, Line feed or Tab. Add operational key characters behind scanning results through keyboard simulation.

- None: no operation.
- Carriage return: add an enter behind scanning results through keyboard simulation.
- Line feed: add an OK operation behind scanning results through keyboard simulation.
- Tab: add a Tab key operation behind scanning results through keyboard simulation.

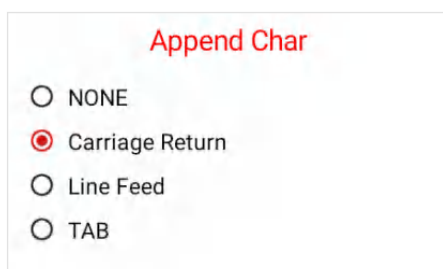

## Encode

The encode is UTF-8 by default. This option needs to correspond to the of 2D codes. Any mismatch between the two may lead to code garbling. Please use this function with care.

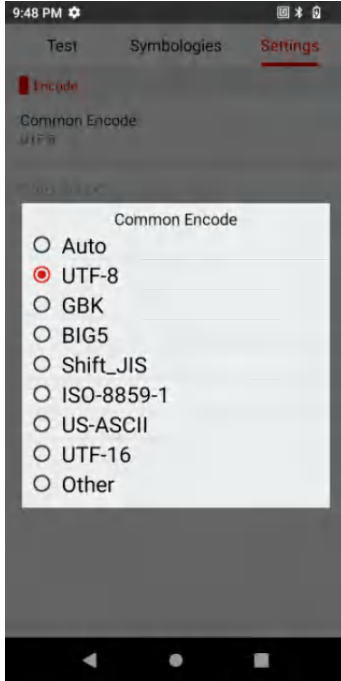

## Other settings

- Decode Timeout - laser duration for failing in single scanning, range of 50-60000 ms, 5000 ms by default.
- Repeat Decode Timeout - laser duration for failing in single scanning, range of 50-60000 ms, 3000 ms by default.
- Continue Scan Interval - laser duration for failing in single scanning, range of 0-5000 ms, 50 ms by default.

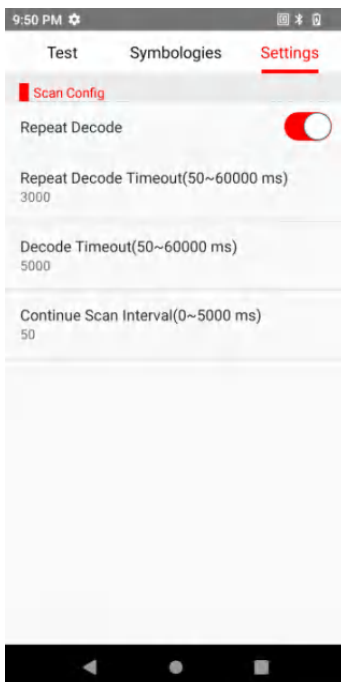

## Reader params

### Exposure Settings

Different scanning heads vary from each other in the settings. HS7 scan engine is taken as example for illustration.



#### 1. Lights Configuration

- Illum/Aimer Off: turn off illumination/aimer light.
- Aim Only: turn on aim light only.
- Illum Only: turn on illumination only.
- Alternating: turn on illumination and aim light in alternation.
- Concurrent: turn on illumination and aim light at the same time.

2. Exposure Mode: auto/fixd. In the auto mode, the scanning head may automatically regulate the exposure value; in the fixed mode, the exposure value can be set.

3. Fixed Exposure: 20~300. The higher the value is, the brighter it will be.

### Decoding Windowing

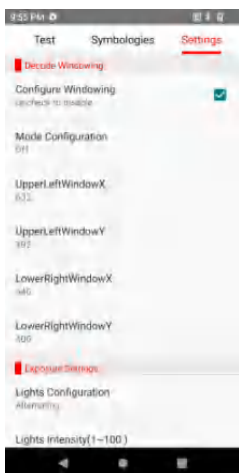

- Configure Windowing - set the range of bar codes from any photo taken.
- Mode Configuration - Off, Around Aimer, or Field of View, Picklist Mode. To fit the view finder, select the Around Aimer mode.
- UpperLeftWindow X.
- UpperLeftWindow Y.
- LowerRightWindow X.
- LowerRightWindow Y.

## Data Format

Upon access of bar codes, the system may be available for additional functions: Formatting, Prefix, Suffix, Substitute, App Identifier, or Code Id Type.

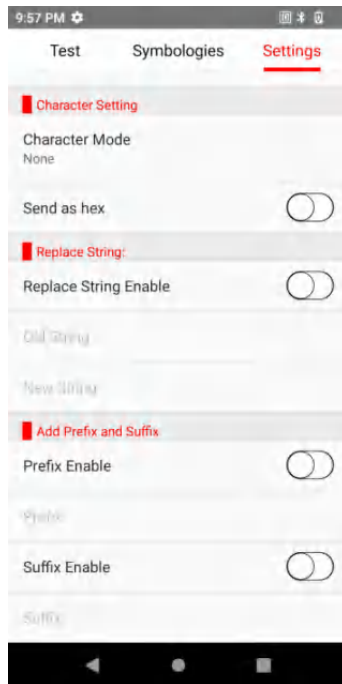
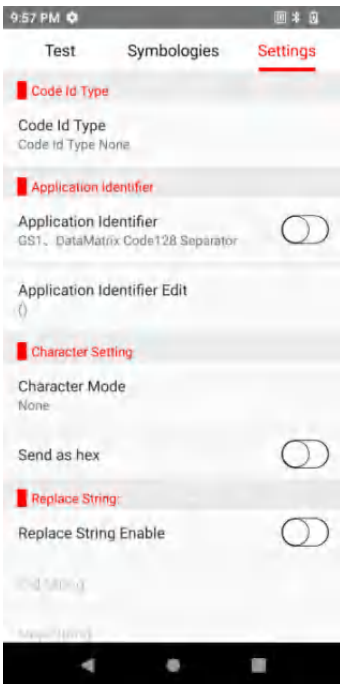

1. Tap "Data Format" and select the additional formatting type.
2. Suffix: select the mode and modify the suffix content, e.g.

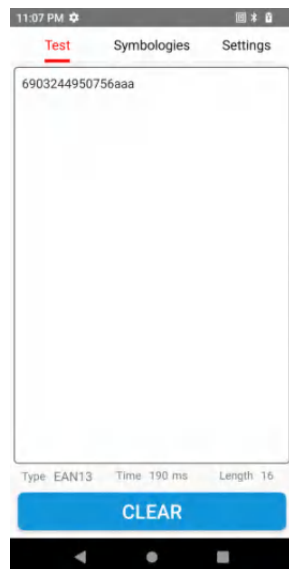
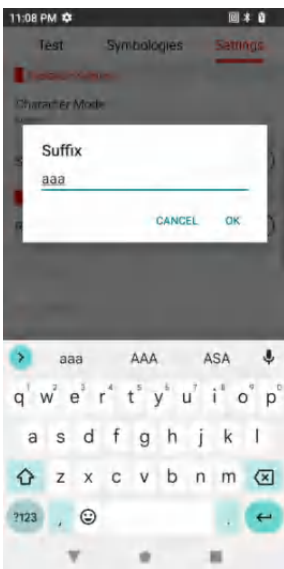

3. Prefix: select the mode and modify the prefix content, e.g.

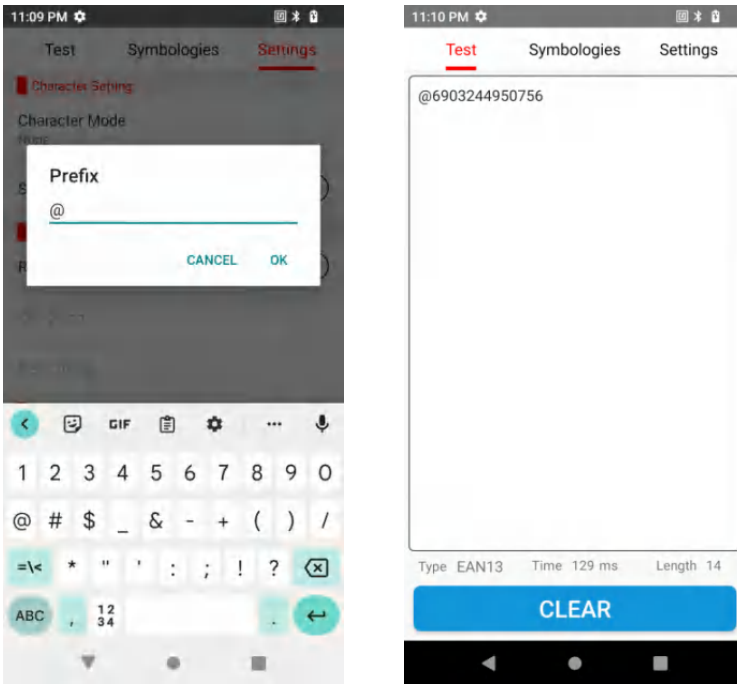

4. Replace: select the mode and modify the former character to be substituted and the substitute character and set the value of the substituted and that of substitute.

5. Application Identifier: select the mode and add an app identifier to some bar codes, e.g., Code 128.

6. App Delimited Identifier: select the mode and set "(" as the app delimited identifier by default, which may be substituted by any other identifier.

7. Code Id Type: select the mode and add a Code Id (Code Id Type None, Code Id Type Aim (add an Aim in front bar codes) or Code Id Type Symbol (add an identifier in front of bar codes)) to some bar codes.



## Symbology settings

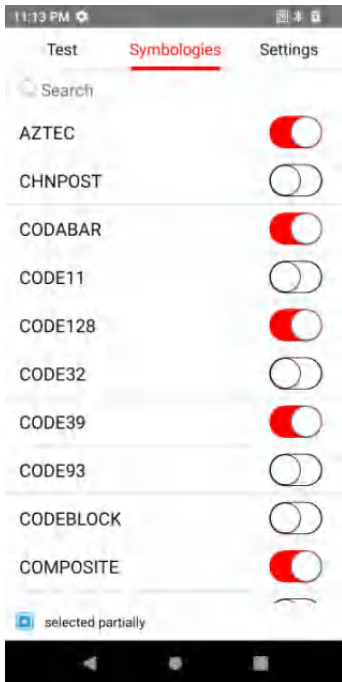

Modify code system type parameters in the list, e.g., bar code length, check bit or transfer character.

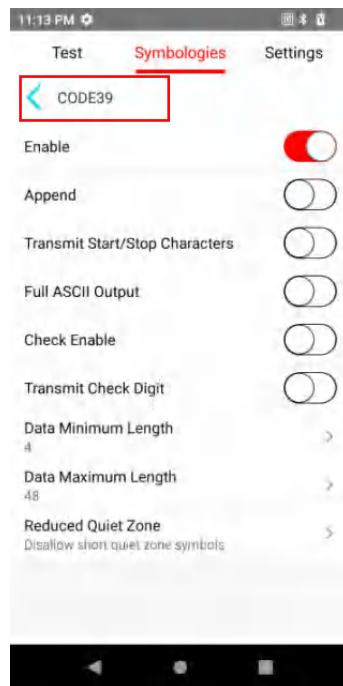
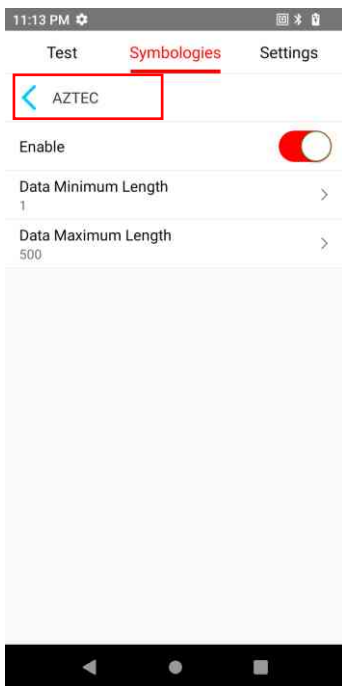

- Enable: enable.
- Data Minimum Length: minimum length.
- Data maximum Length: maximum length.
- Transmit Check Digit: check bit in transfer.

## Reset

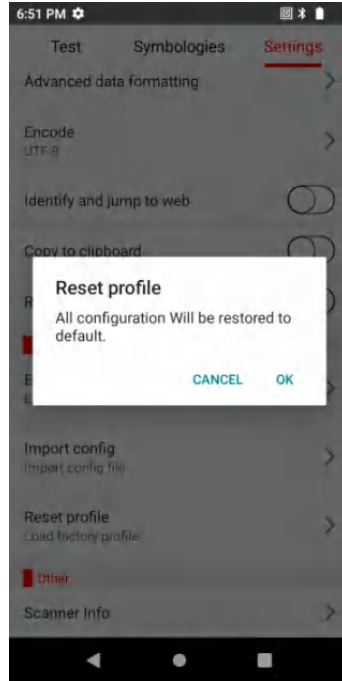
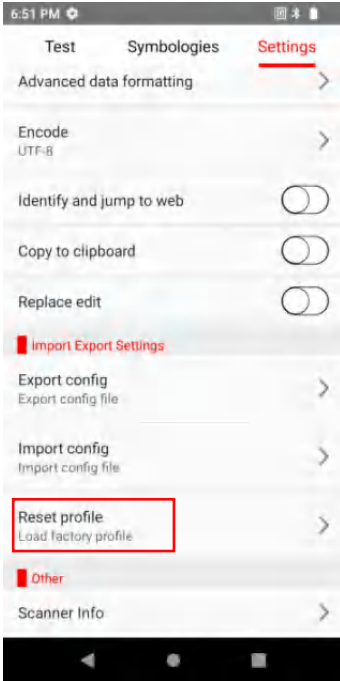

## Import config/Export config

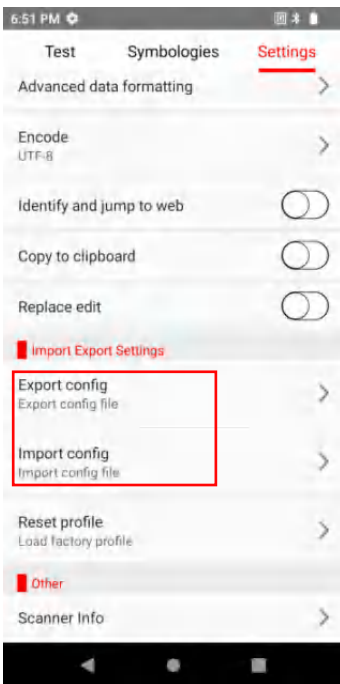

# Wireless

## WLAN

To enable the WLAN function, please operate as following:

### Connect to WLAN

After the wireless function is enabled, ME65 will automatically display all the available wireless networks nearby in the wireless network list. To connect to a certain wireless network, please click the network's SSID in the list and tap Connect.

Note: For some networks, network security key or password needs to be entered for connecting. To connect to such networks, please contact the network admin for corresponding network security keys or passwords.

1. Open Settings - Network & internet or pull down the status bar to enter the quick access panel for operation;

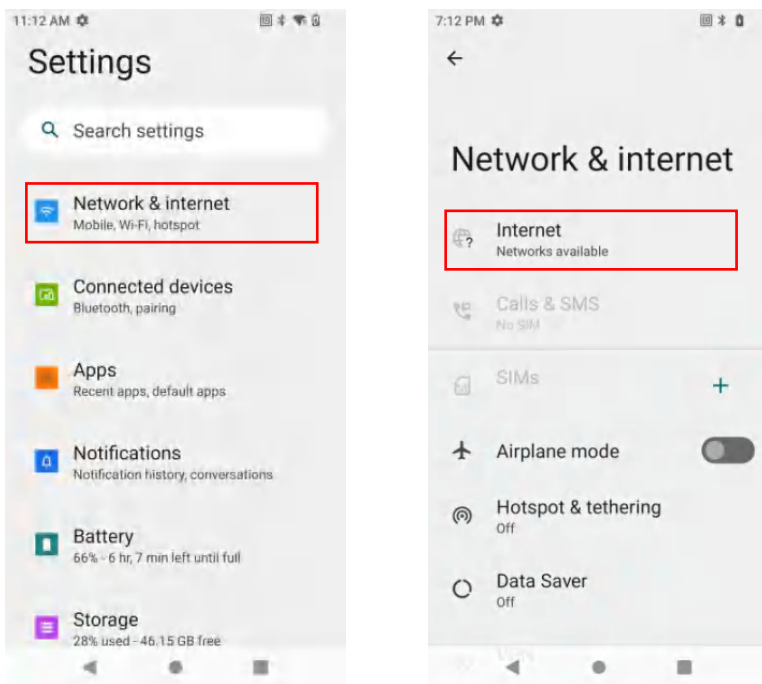

2. Touch to turn on the wifi function.

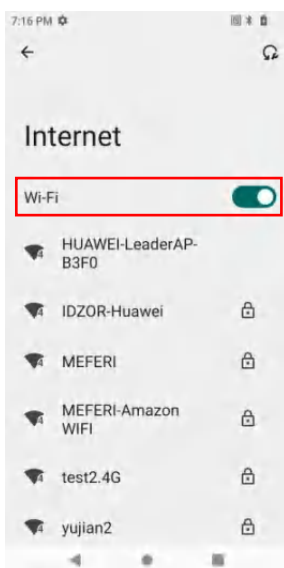

3. Enter the password and tap "✓".

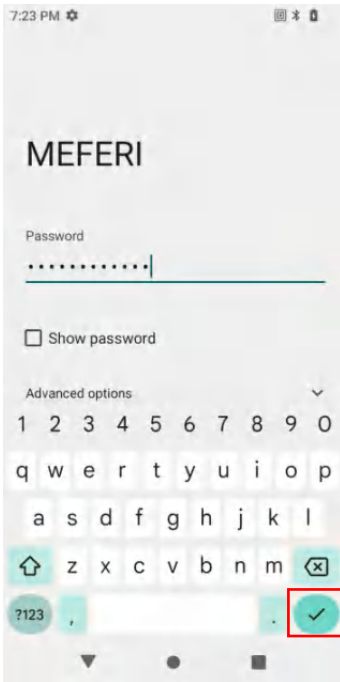

- Check Show Password to display the hotspot password to check whether the password input is wrong.
- Check Advanced Settings for advanced settings, including agent and IP settings.

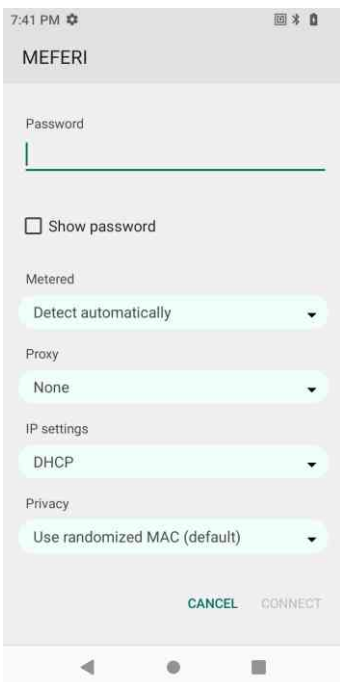

4. Check whether connection is done: 'Connected' indicates that connection is done.

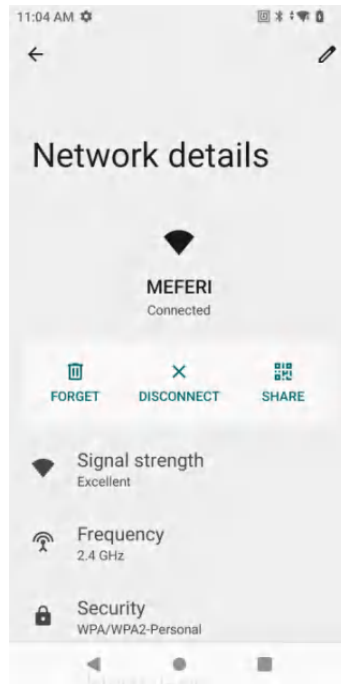
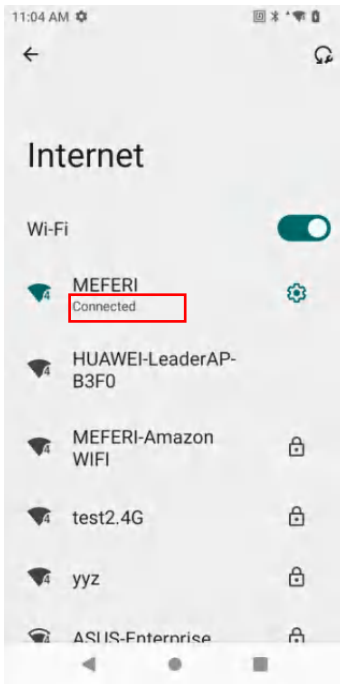

5. WLAN allows indoor wireless communication of ME65. ME65 supports WI-FI in two frequency bands: 2.4G and 6G. WLAN security options support below protocols.

- None
- Enhanced Open
- WEP
- WPA/WPA2-Personal
- WPA3-Personal
- WPA/WPA2-Enterprise
- WPA3-Enterprise
- WPA3-Enterprise 192-bit

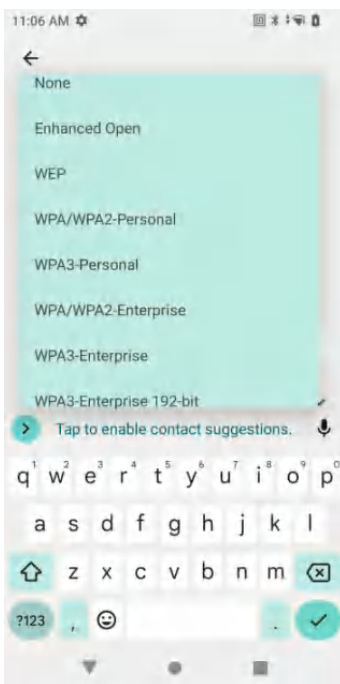

## WWAN

Please refer to "Instruction on SIM/TF Card installation" for how to insert a SIM Card.

1. Open "Settings" - "Network & internet" - "SIMs".

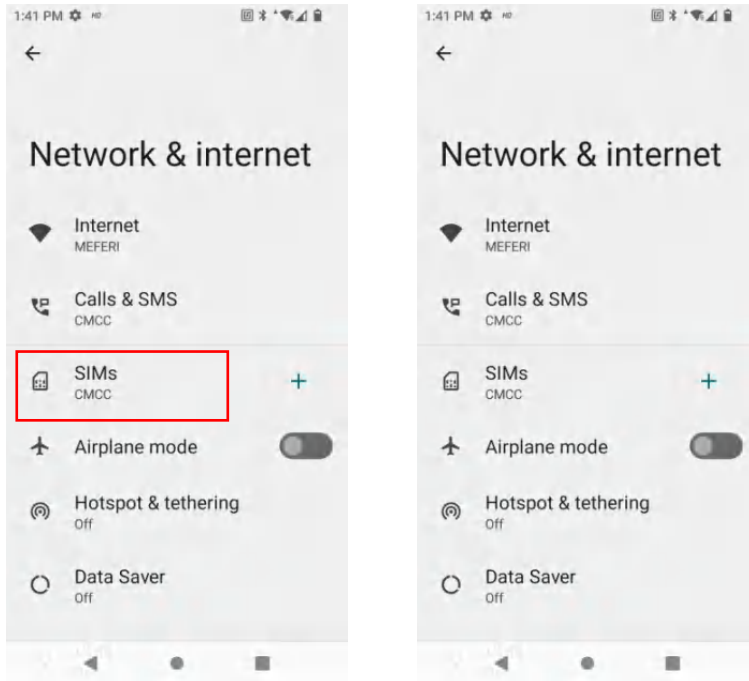

2. Can set the mobile network in conjunction with carrier information settings, such as data on/off, roaming on/off, and access point name, etc.

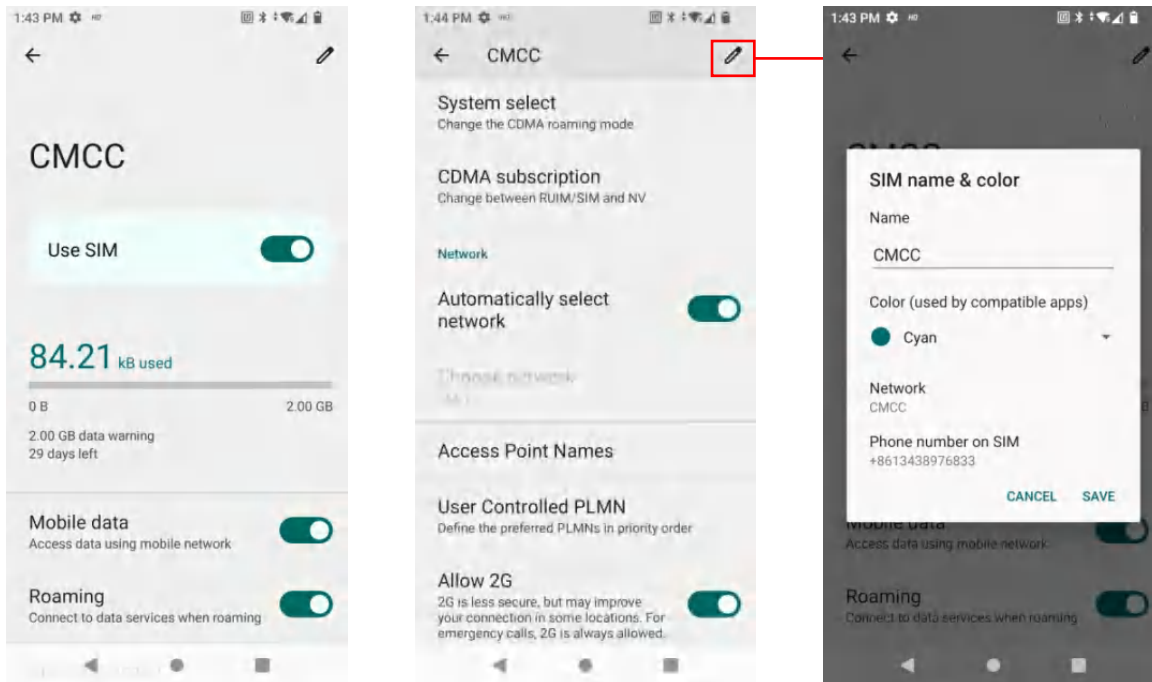

3. App data usage can set traffic usage limits.

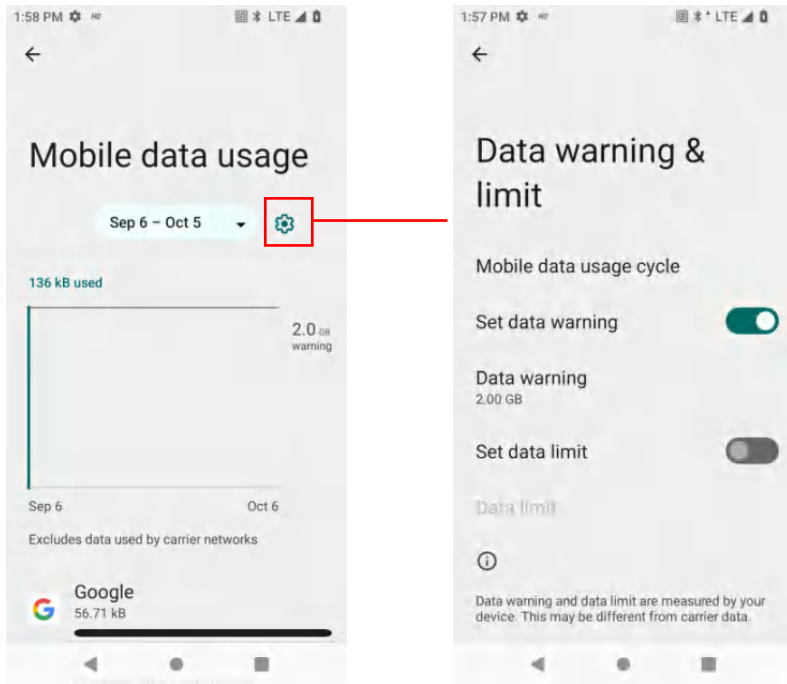

4. Access Point Names.

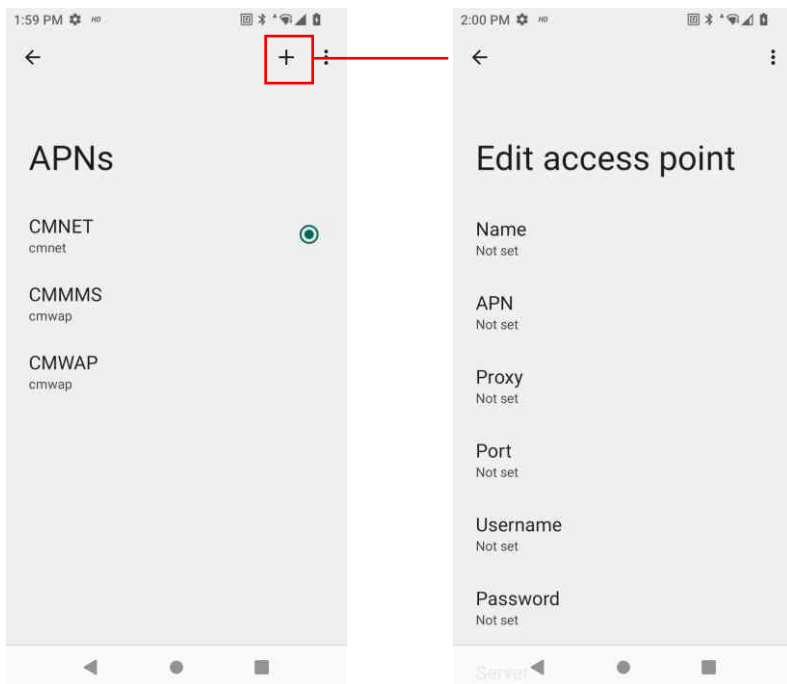

5. ME65 supports a wide range of 5G networks . If failed to connect to WWAN, please follow as below:



- Check local network signal intensity.
- Check whether the SIM Card is correctly installed.
- Check whether the SIM Card has any pending bill, is available for surfing the Internet or damaged (test whether the SIM Card is damaged or has any pending bill by loading the SIM Card in the device).

- Check whether the access point is correctly set.

## Bluetooth

Any device with Bluetooth is available for wireless communication to transmit and receive data by wireless radio frequency (2.4 GHz).

Device with the Bluetooth function such as printer, access point and other mobile computer can exchange data (e.g., file, date or task) after turning on the Bluetooth function.

ME65 supports BLE (Bluetooth low energy). BLE is oriented to healthcare, health, safety and home entertainment apps. It remains a standard Bluetooth coverage while reducing power consumption and saving cost.

1. Pull down the status bar and long press the Bluetooth icon or click "Settings" - "Connected devices" to enter the page.

### Method 1

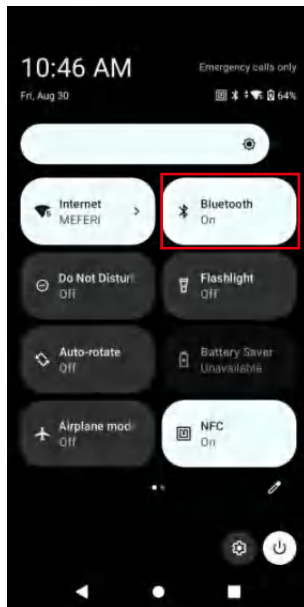

### Method 2

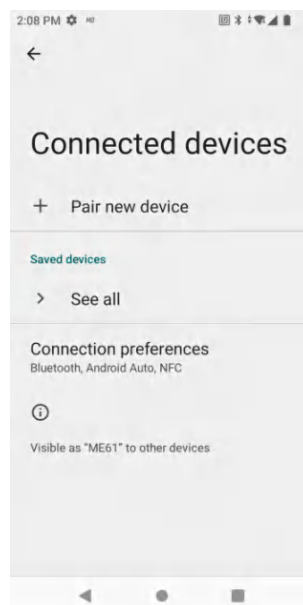
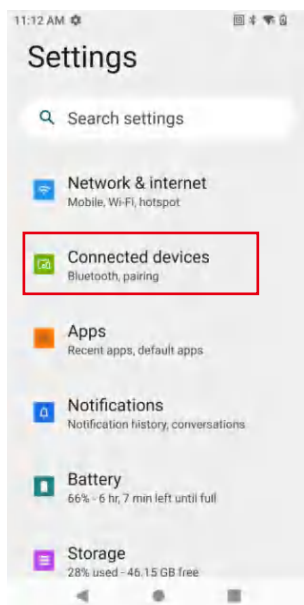



## Change Bluetooth device name

1. Click Pair new device.

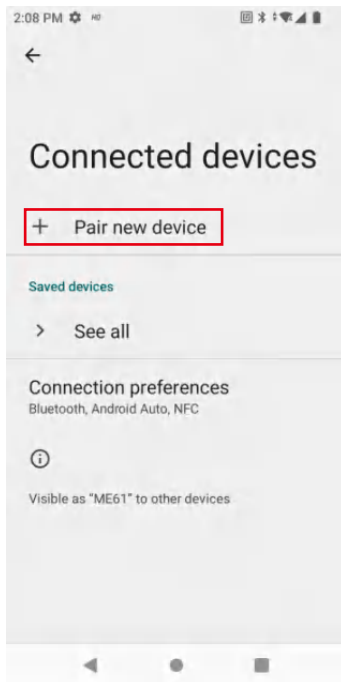

2. Tap Device name can change visible name to another.

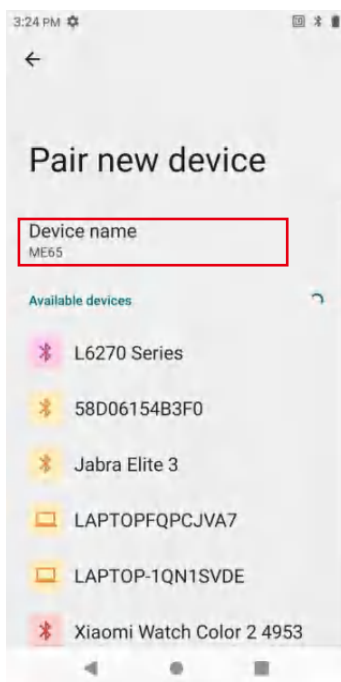

## Bluetooth connection

1. Tap Pair new device to search for Bluetooth devices nearby.

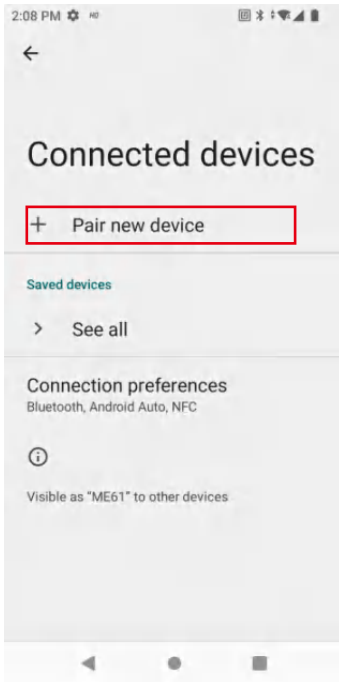

2. Tap the device to be connected and enter PIN code for verifying pairing or request for entering PIN code.

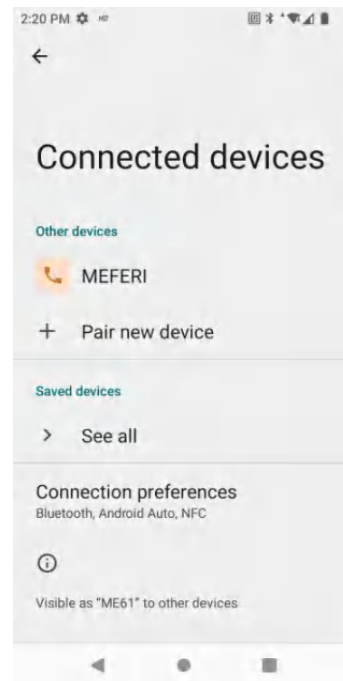
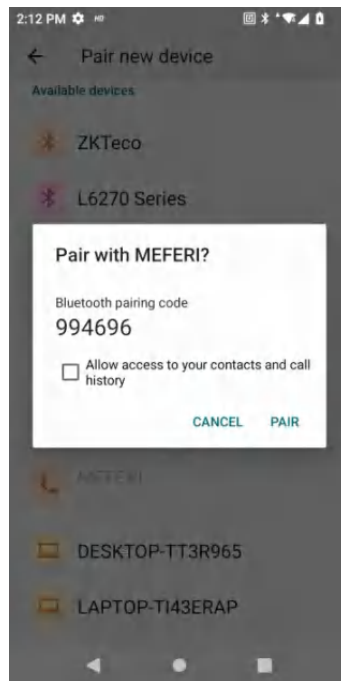

## Management paired devices

1. Click the previously connected device settings icon.

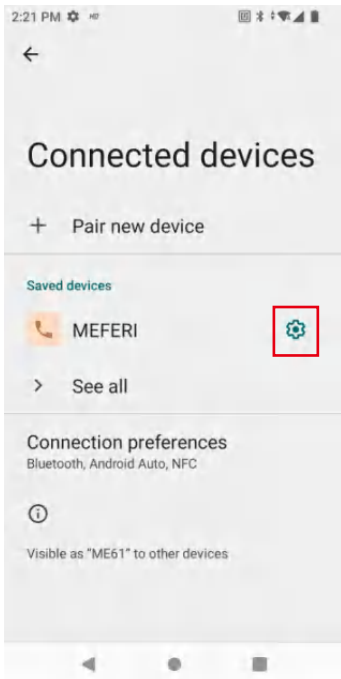

2. Can perform management operations such as "forget" and "connect" on previously connected devices.

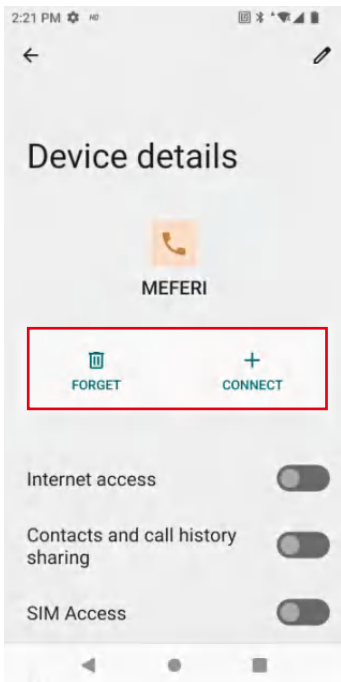

## Connection preferences

1. Set up Bluetooth, NFC, etc.

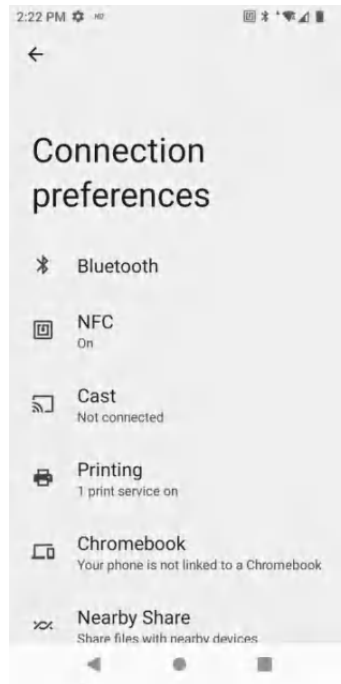
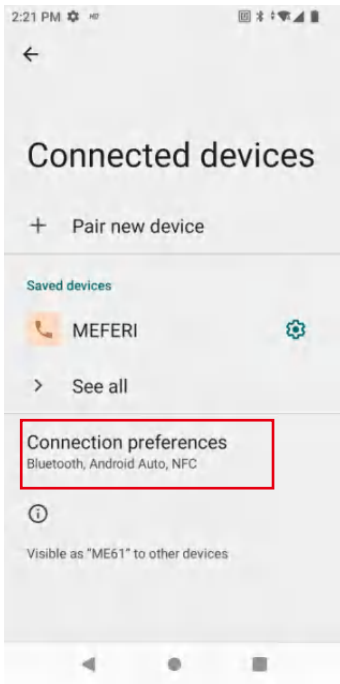

# Accessories

## Introduction

This chapter describes ME65 accessories.

## List of Standard Accessories



USB Type-C Cable

- Support Charging and Data Transferring.
- USB 2.0 Port: OTG, Type-C.
- Length: 1m.



Battery

- Standard Battery: 3.85V/5000mAh.



Hand Strap

- Convenient for Mobile Operation and Carrying Around.

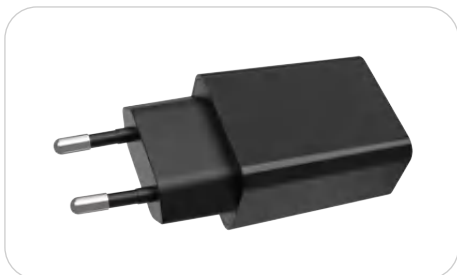

Power Adapter

- Input: 100-240V 50/60Hz 0.6A.
- Output: 3.6-6.0V—3.0A 18.0W 6.0-9.0V—2.0A 18.0W 9.0-12.0V—1.5A 18.0W.
- ME65: 9V/2A Quick Charge.

## List of Optional Accessories



Single Slot Cradle

- Support Charging One Device and One Battery.
- DC Jack Charging Port.
- Charging Cradle Adapter Output: 12V/2A.
- Support Type-C Data Transferring Battery.
- Support Charging and Communicating with Solid Rubber Boot and Wearable Strap.
- LED Charging Status Indicator: Red for Charging, Green for Full Battery.



MeMobilityDesk WorkSpace Cradle

- Connect the 12V/2A charger to the DC interface on the back of the single-slot cradle. Connect the cradle to any HDMI LCD monitor using an HDMI cable, and attach the two USB interfaces to a mouse and keyboard or use Bluetooth. Connect the cradle via the Ethernet interface to a network cable, or use Wi-Fi/4G/5G on the ME61 or ME65. Then, insert the ME6X device into the cradle slot to transform any place into a WorkStation without needing a PC. Use Android Apps, connect with RDP to your server software, and utilize Browser - Based Software, ERP, CRM, B2B, etc. The device and battery can also be charged while in desktop mode.

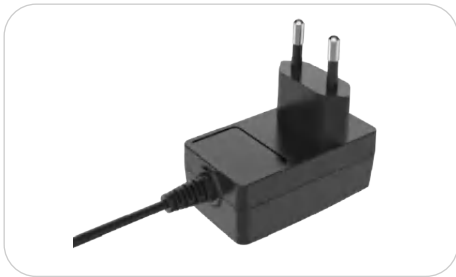

Power Adapter

- Power Supply-12V/2A/DC Interface-Black-Europe Standard.



4-Slot Battery Charger

- Support Charging 4 Batteries.
- DC Jack Charging Port.
- Charging Cradle Adapter Output: 12V/4A.
- LED Charging Status Indicator: Red for Charging, Green for Full Battery.

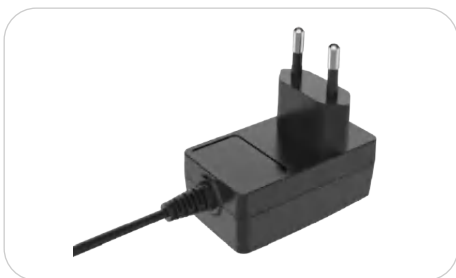

Power Adapter

- Power Supply-12V/4A/DC.
- Interface-Black-Europe Standard.

## List of Optional Accessories



5-Slot Cradle

- Support Charging 5 Devices and 5 Batteries.
- DC Jack Charging Port.
- Charging Cradle Adapter Output: 12V/4A.
- LED Charging Status Indicator: Red for Charging, Green for Full Battery.



Power Adapter

- Plug Adaptor 24V5A.
- Plug Cable 100-240V.



Screen Protector(Glass )

- Protect Screen Glass.



Pistol Grip

- Scanning with Trigger Button.
- Comfortable Grip.

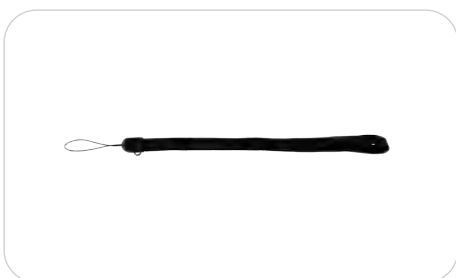

Pistol Grip Hand Strap

- For Pistol Grip

## List of Optional Accessories



Shoulder Bag

- Convenient for Carrying Around.



Protective Boot

- Improve Device Protection.



Vehicle Charger

- Vehicle Charger Pogo Pin for ME61/ME65.



# Maintenance and Troubleshooting

## Introduction

This chapter sets forth the device's maintenance methods and troubleshooting solutions to help users use the product appropriately.

## Maintenance

To ensure that the device does not break down, please abide by the following instructions while using ME65:

- Do not scratch the screen of ME65. While using ME65, please use a recognized touch pen or any other pen which is fit for touching with point made from plastics. Please do not use a real pen, pencil or anything sharp to touch the screen of ME65.
- The screen of ME65 is made from glass. So please do not make ME65 fall on the ground or get hit.
- Prevent ME65 from bearing too high or low temperature. Do not put the device on any automotive instrument panel in hot weather. Keep it away from any heat source.
- Do not use ME65 anywhere dusty, damp or moist.
- Clean the scanning head and camera of ME65 by soft lens cloth. If the screen of ME65 gets dirty, please clean the screen by soft cloth with diluted glass cleaning solution.

## ME65 cleaning

### Housing

Scrub the housing by cloth with alcohol, including keys.

### Display screen

Scrub the display screen by alcohol wipes but be sure that no liquid drops nearby the edge of the display. Immediately dry the display screen by soft and abrasive-free cloth to prevent mark left.

### Camera and scanning window

Please scrub the camera and scanning window by lens wipers or other materials made for cleaning optical materials (e.g., glasses).

## Troubleshooting

ME65 troubleshooting.

Problem	Reason	Solution
Press the power key but ME65 does not work.	The battery is not charged.	Charge the battery in ME65.
	The system crashes.	Execute resetting.
The battery is not charged.	The battery breaks down.	Replace the battery.
	The battery's temperature is exceptional.	Contact for technical support.
During data communication via Wi-Fi, no data are transferred or not all data are transferred.	Wi-Fi communication is not enabled.	Turn on Wi-Fi communication.
	The device is out of the range of the access point.	Move closer to the access point.
During data communication via Bluetooth, no data are transferred or not all data are transferred.	Bluetooth communication is not enabled.	Turn on Bluetooth communication.
	The device is out of the signal range of another Bluetooth device.	Move within 10m (32.8ft) range of another device.
No sound.	Volume setting is too low or turned off.	Adjust volume.
ME65 is off.	ME65 is at inactive state.	Not use for a while, the display will automatically turn off. Set the duration to be longer, such as 15 s, 30 s, 1 min, 2 min, 5 min, 10 min or 30 min.
	The device runs out of battery.	Charge the battery.
Tapping a window button or icon but fail to trigger the corresponding function.	The device does not respond.	Reset the device.
A message pops up, indicating that ME65's storage is full.	Too many files are saved in ME65.	Delete unused memos and records. If necessary, save such records in the host (or use SD Card as additional memory).
	Too many apps are installed in ME65.	Uninstall unused apps in ME65 to recover storage capacity.
ME65 fails to decode while reading a bar code.	The bar code is unreadable.	Check the barcode is not damaged.
	The distance between the laser scanning window and bar code is wrong.	Put ME65 within proper scanning range.
	Battery low.	Check battery capacity.